

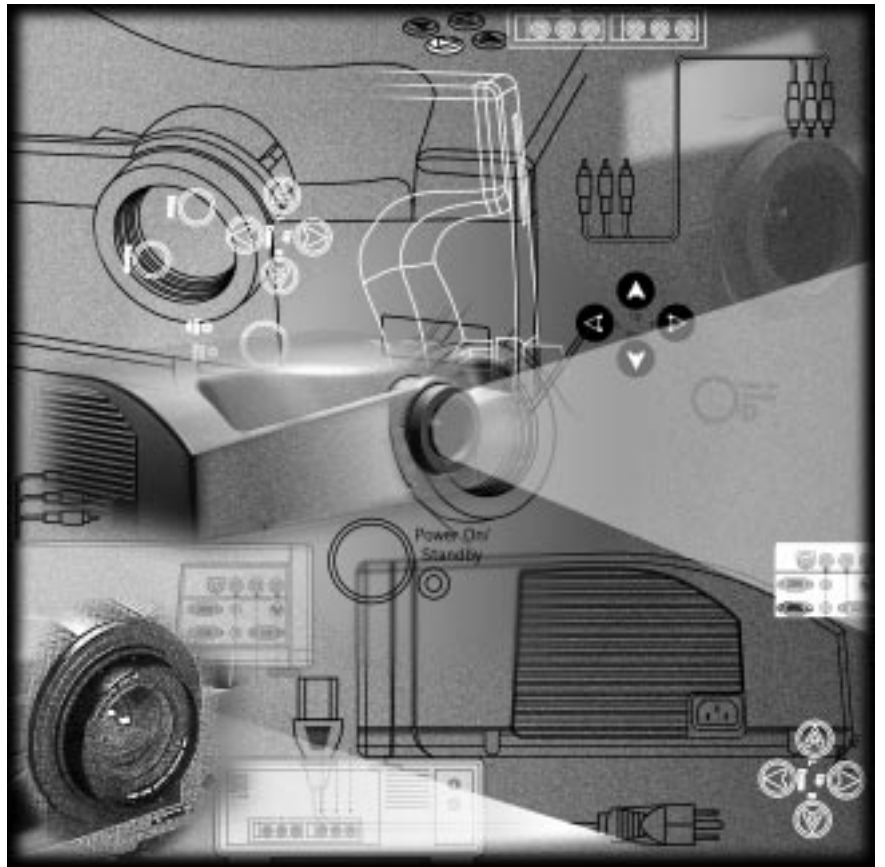

Polaview 215E



LCD Projector User's Guide

Table of contents

General information	
Declaration of Conformity _____	6
Important safeguards _____	7
Introduction	
LCD projector features _____	10
Contents of the LCD projector box _____	12
Parts list and accessories _____	13
Remote control unit _____	13
Before using the remote control _____	14
Battery replacement caution _____	14
LCD projector _____	15
LCD projector back/bottom _____	16
Getting started	
How to use the remote control unit _____	17
Setting up the LCD projector _____	18
Positioning the LCD projector _____	18
Adjusting the lens _____	19
Rear screen mode projection _____	19
Connecting the LCD projector _____	20
Connecting to a computer (RGB signal) _____	20
Connecting to audio/video output equipment (S-VIDEO/VIDEO signal) _____	21
Computer cables & adapters _____	22
Pin assignments _____	23
Setting the DIP Switches _____	24
Factory preset timing _____	26
Turning the power on and off _____	30
Turning on the power _____	30
Turning off the power _____	31
Positioning the LCD projector and screen _____	31
Basic LCD projector operation _____	33
Special effects while projecting _____	34

Using other useful functions _____	35
Selecting the Language for On-Screen Displays (for Model PV215E-C only) _____	35
Selecting the Video System Format _____	35
Turning off the input signal display _____	36
Disabling the POWER button on the remote control unit _____	36
Canceling the enlarging (scanning line conversion) function _____	37
Changing to 16:9 (wide) screen format _____	37
Blue Screen with no input signal _____	38
Adjusting the projected image _____	39
Input image adjustment _____	39
Adjustments for input image _____	40
Recall standard settings _____	40
RGB sync adjustment _____	41
Adjustments for RGB input _____	42
Adjusting the white balance _____	44
Selecting the picture memory _____	45
Projecting PC-Card (ATA Flash Card) data _____	46
When using the Repeat Play _____	47
JPEG Viewer features _____	48
System requirements _____	48
JPEG Viewer installation _____	48
How to make JPEG files _____	48
Capture feature _____	48
Starting up the JPEG Viewer _____	49
Functions of each menu item _____	50
When using the Capture feature _____	51
Size of the projected screen _____	52
How to edit using the Album Display feature _____	52
Changing the image display order in Folder _____	52
Moving the images between Folders _____	53
Displaying full-screen images for confirmation _____	53
Deleting images _____	53
When using the BMP to JPEG Converter feature _____	53

ProMouse Control Feature	54
Windows 95 / Windows 98	54
System requirements	54
ProMouse installation	55
To open the ProMouse Software	55
Using the ProMouse Software	56
To start the ProMouse Control feature	56
To Use the Auto Setup feature	56
ProMouse Software details	56
Macintosh	58
System requirements	58
ProMouse installation	58
To open the ProMouse Software	59
Using ProMouse Software	59
To start the ProMouse Control feature	59
To Use the Auto Setup feature	60
ProMouse Software details	60
Appendix	
Maintenance	62
Warning Indications	62
Status Code Display Indications	62
Cleaning the Air Filter	63
Cleaning procedure	63
Lamp Replacement	65
Lamp replacement period	65
Lamp replacement procedure	66
Before Requesting Service	69
Where to get help	69
Specifications	70
Polaroid Three Year Limited Warranty	72
U.S.A. and Canada	72
Outside the U.S.A. and Canada	72
Polaroid Offices and Service Centers	73

General information

Caution: This equipment has been tested and found to comply with the limits for a Class B digital device, pursuant to Part 15 of the FCC Rules. These limits are designed to provide reasonable protection against harmful interference in a residential installation. This equipment generates, uses, and can radiate radio frequency energy and, if not installed and used in accordance with the instructions, may cause harmful interference to radio communications. However, there is no guarantee that interference will not occur in a particular installation. If this equipment does cause harmful interference to radio or television reception, which can be determined by turning the equipment off and on, the user is encouraged to try to correct the interference by one or more of the following measures:

- Reorient or relocate the receiving antenna.
- Increase the separation between the equipment and receiver.
- Connect the equipment into an outlet on a circuit different from that to which the receiver is connected.
- Consult the dealer or an experienced radio/TV technician for help.

FCC Warning: To assure continued FCC compliance, use only the provided power supply cord and prevent undesirable interference, use only the provided shielded VGA cable with 2 ferrite cores while connecting LCD to computer and all other connecting cables should be shielded. Any changes or modifications not expressly approved by the party responsible for compliance could void the user's authority to operate the equipment.

This device complies with Part 15 of the FCC Rules. Operation is subject to the following two conditions: (1) This device may not cause harmful interference, and (2) this device must accept any interference received, including interference that may cause undesired operation.

Declaration of Conformity

Model Number: PV215E

Trade Name: Polaroid

Responsible Party: Polaroid (Europa) BV

Address: Hoge Botofstraat 45 7511 ZA, Enschede,
The Netherlands

Telephone Number: 31-53-486-5050

This device complies with the following directives and standards:

89/336/EEC: EN55022, EN50082-1, IEC801-2, IEC801-3, IEC801-4,
EN61000-3-2, EN61000-3-3

73/23/EEC: EN 60950: A1, A2, A3

Thank you

for purchasing the Polaroid Polaview PV215E LCD Projector, one of the most sophisticated and reliable products on the market today. Used properly, it will bring you years of service. Please take time to fill in the information below. The serial number is on the tag located on the back of your LCD projector. You'll want to keep this information handy as your convenient LCD projector information source. For your own protection and prolonged operation of your LCD projector, please be sure to read the "Important safeguards" carefully before use.

Date of Purchase

Dealer Purchased From

Dealer Address

Dealer Phone No.

Model No. PV215E

Serial No.

"Polaroid" and Polaview" are trademarks of Polaroid Corporation, Cambridge, MA, U.S.A. Other product/brand names may be trademarks of the respective owners.

Important safeguards



Caution: Please read all of these instructions before you operate your LCD projector. Keep these instructions in a safe place for future reference.

Machine Noise Information Ordinance 3. GSGV, January 18, 1991: The sound pressure level at the operator position is equal or less than 44dB (A) according to ISO7779. (However, this is when the ambient temperature is less than 30°C.)

Electrical energy can perform many useful functions. This LCD projector has been engineered and manufactured to meet applicable safety standards. But improper use can result in potential electrical shock or fire hazards. In order not to defeat the safeguards incorporated into this LCD projector, observe the following basic rules for its installation, use, and servicing.

1. Unplug the LCD projector from the power point before cleaning.
2. Do not use liquid cleaners or aerosol cleaners. Use a soft dry cloth to clean the LCD projector unit. If the unit is very dirty, wet a cloth with neutral detergent, squeeze it tight, wipe the unit with it, and finish by wiping with a dry cloth. Do not use a chemical duster or polisher-cleanser because it can adversely affect the unit and peel the paint coat.
3. Do not use attachments not recommended by Polaroid, as they may cause hazards.
4. Do not use the LCD projector near water; for example, near a bathtub, washbowl, kitchen sink, laundry tub, in a wet basement or near a swimming pool. Never spill liquid into the LCD projector.
5. Do not place the LCD projector on an unstable cart, stand, or table. The LCD projector may fall, which may cause serious injury to a child or an adult and/or serious damage to the unit. Use only with a cart or stand recommended by its manufacturer as being suitable for use with an LCD projector.
6. Ceiling, wall, or shelf mounting for installation should use a mounting kit approved by the manufacturer for use with an LCD projector and should follow the manufacturer's instructions.
7. LCD projector equipment and cart combinations should be moved with care. Quick stops, excessive force, and uneven surfaces may cause the equipment and cart combination to overturn.
8. Slots and openings in the cabinet back and bottom are provided for ventilation. To ensure reliable operation of the LCD projector and to protect it from overheating, these openings must not be blocked or covered. These openings should never be covered with cloth or other materials. The bottom opening should not be blocked by placing the LCD projector on a bed, sofa, rug, or other similar surface. The LCD projector should not be placed near or over a radiator or heating vent. The LCD projector should not be placed in a built-in installation such as a bookcase unless proper ventilation is provided.
9. The LCD projector should be operated only from the type of power source indicated on the back of the LCD projector or in the specifications. If you are not sure of the type of power supplied to your home, consult your LCD projector dealer or local power company.

10. Do not allow anything to rest on the power cord. Do not place the LCD projector where the cord will be walked on.
11. Follow all warnings and instructions marked on the LCD projector.
12. As a safety feature, this LCD projector is equipped with a 3-prong earthed plug. The 3-prong earthed plug will fit only into a earthing-type power outlet. If the plug does not fit, use an adapter that is properly earthed or have an electrician install an earthing-type outlet. Do not attempt to modify this AC plug.
13. For added protection for the LCD projector during a lightning storm, or when it is left unattended or not in use for long periods of time, unplug it from the power point and disconnect any cable systems. This will prevent damage to the projector due to lightning and power-line surges.
14. Do not overload power points and extension cords with too many products, because this can result in fire or electric shock.
15. Never push objects of any kind into the LCD projector through cabinet slots, as they may touch dangerous voltage points or short out parts, which could result in a fire or electric shock.
16. Do not attempt to service the LCD projector yourself. Opening or removing covers may expose you to dangerous voltages or other hazards. Refer all servicing to qualified service personnel.
17. Unplug the LCD projector equipment from the power point and refer servicing to qualified service personnel under the following conditions:
 - a. When the power cord or plug is damaged or frayed.
 - b. If liquid has been spilled into the LCD projector.
 - c. If the LCD projector has been exposed to rain or water.
 - d. If the LCD projector does not operate normally when you follow the operating instructions. Adjust only those controls that are covered by the operating instructions; improper adjustment of other controls may cause damage and will often require extensive work by a qualified technician to restore the LCD projector to normal operation.
 - e. If the LCD projector has been dropped or the cabinet has been damaged.
 - f. When the LCD projector exhibits a distinct change in performance—this indicates a need for service.
18. Upon completion of any service or repairs to the LCD projector ask the service technician to perform a routine safety check to determine that the LCD projector is in safe operating condition.

19. When replacement parts are required, be sure the service technician has used replacement parts specified by the manufacturer that have the same characteristics as the original parts. Unauthorized substitutions may result in fire, electric shock or other hazards.
20. The air filter should be cleaned every 100 hours of lamp use. The LCD projector may become too hot if the filter is not cleaned when required.
21. If the lens becomes dirty or smudged, clean with a clean, dampened cloth. Never touch the lens with your fingers.
22. Do not look directly into the aperture and lens while operating the LCD projector, as this may result in damage to your eyes.
23. We make an effort to keep your environment clean. Please bring the not repairable unit to your dealer or a recycling company.

Introduction

LCD projector features

High brightness and resolution

1,440 K-pixel, 600-lumen (ANSI) offers clear images even when ambient light level is high.

Compact and lightweight

Because it is completely portable, you can give attractive presentations at any location by connecting the LCD projector to an external device such as a notebook computer.

20 to 300 inch screen capability

20" (0.97 m) to 300" (15.8) diagonal screen size. (See table on page 32.)

Compatible with most personal computers

The RGB input accepts signals from VGA, SVGA, XGA (Compression), and MAC compatible computers with no additional hardware. Other computers require a separate cable.

On-screen display

This LCD projector's language is set to English at the factory. In addition, you can select Spanish, French, German or Italian.

Information screens and menus make setting up and operating the LCD projector extremely easy.

IR remote control

Front and rear sensors allow you to control the projector from almost anywhere in the room.

Stereo audio output

For external audio equipment connection.

ProMouse control feature

This feature lets you use the LCD Projector remote control unit as a mouse to control your personal computer. There is also an Auto Setup feature which identifies the signal mode and automatically adjusts the Vertical position, Horizontal position, Horizontal size and Phase. (See page 46)

Projected PC-Card (ATA Flash Card) data

Using this software, "JPEG Viewer", you can save the image displayed on the PC screen as a JPEG file, to a PC-Card (ATA Flash Card). And if you insert the PC-Card into this LCD projector, you can project the image using the JPEG Image playback feature. (See page 48.)

Automatic Universal Power Supply with automatic power down

This unit has an operating voltage range of 100-240 V AC. The lamp power is automatically turned off if there is no input signal for 15 minutes.

Video board

This LCD projector accepts input signals in all major video formats, including PAL, SECAM, NTSC, PAL-M, PAL-N and NTSC4.43, as well as the higher quality S-VIDEO signals.

Equipped with a variety of convenient functions

A variety of functions such as the following have been provided.

- A blue screen is projected when no signal is being input.
- Mute or freeze functions for video and audio signals can be toggled on and off.
- The input signal display function can be toggled on and off.
- Cancellation of the enlarging function is provided.
- 16:9 (wide) screen projection is provided.
- The function of the POWER button on the remote control unit can be disabled.
- Rear screen projection is provided.

Contents of the LCD projector box

Please confirm that the following items are packed in the LCD projector box. They are provided to help you use or set up your LCD projector.

- LCD projector
- Remote control unit
- 2 “AA” batteries
- 9.8 ft. UL/CSA power cord or 2.44m power cord
- VGA cable
- VGA MAC adapter
- PC audio cable
- RS-232C cable
- RS-232C 9-pin adapter
- RS-232C 25-pin adapter
- 3.5" floppy disk containing ProMouse Software for Windows 95 & 98
- 3.5" floppy disk containing ProMouse Software for Macintosh
- 3.5" floppy disk containing JPEG Viewer for Windows 95 & 98
- User’s Guide (please read completely before operating)
- Registration card

Parts list and accessories

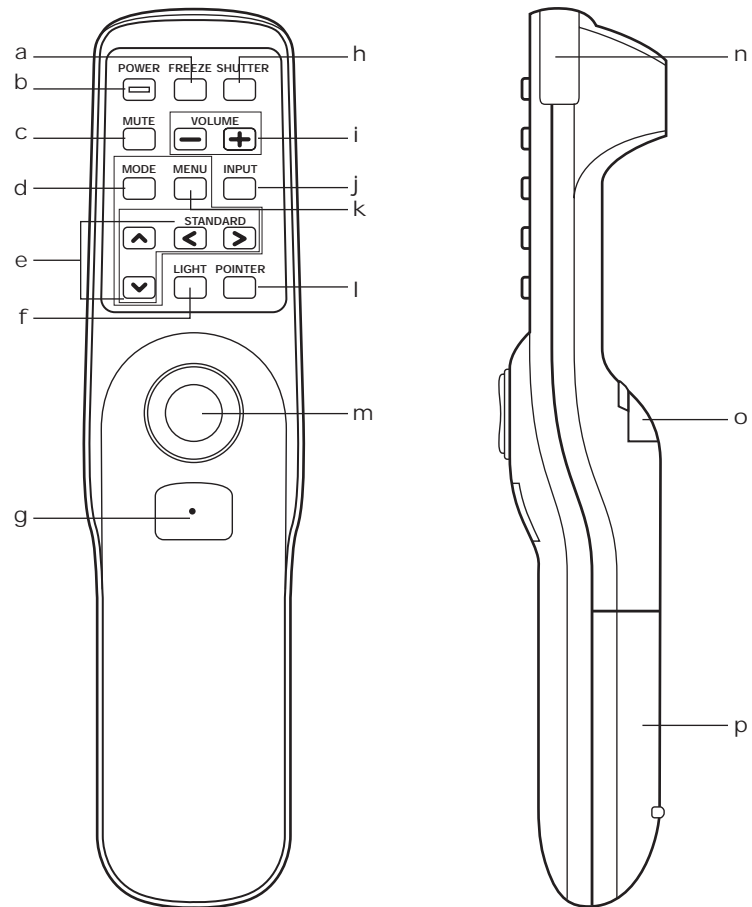
Remote control unit

- a FREEZE button
- b POWER button
- c MUTE button
- d MODE button
- e Adjust ▲ / ▼ / ◀ / ▶ buttons
- f LIGHT button
- g Click 2 button
- h SHUTTER button

- i VOLUME buttons
- j INPUT button
- k MENU button
- l POINTER button
- m Mouse button
- n Transmitter
- o Click 1 button
- p Battery compartment

Before using the remote control

Load the 2 “AA” batteries into the remote control unit.

1. Slide the lid in the direction of the arrow.
2. Install 2 “AA” batteries as indicated inside the battery compartment.
3. Replace the lid and snap it into place.

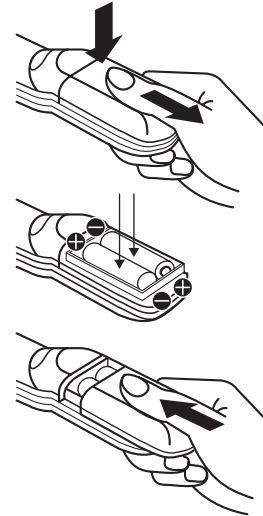

Battery replacement caution

Do not mix old and new batteries. (Also never mix alkaline with manganese batteries)

Note: Do not place the remote control unit upside down, otherwise the mouse button may be pressed down, which will cause the battery power to be consumed.

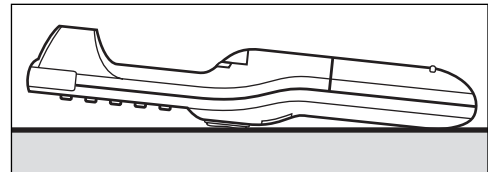

Remote control unit operating range

When using the remote control unit, point it at the front or rear of the LCD projector or at the projection screen. The range for optimum operation is within 30 degrees of the receiver at a maximum distance of about 23 feet (7m).

Remote control unit light up

Press the LIGHT button to illuminate the function buttons on the remote control unit for 10 seconds. The light goes out while any button is pressed, and then turns back on for an additional 10 seconds when the button is released.

LCD projector

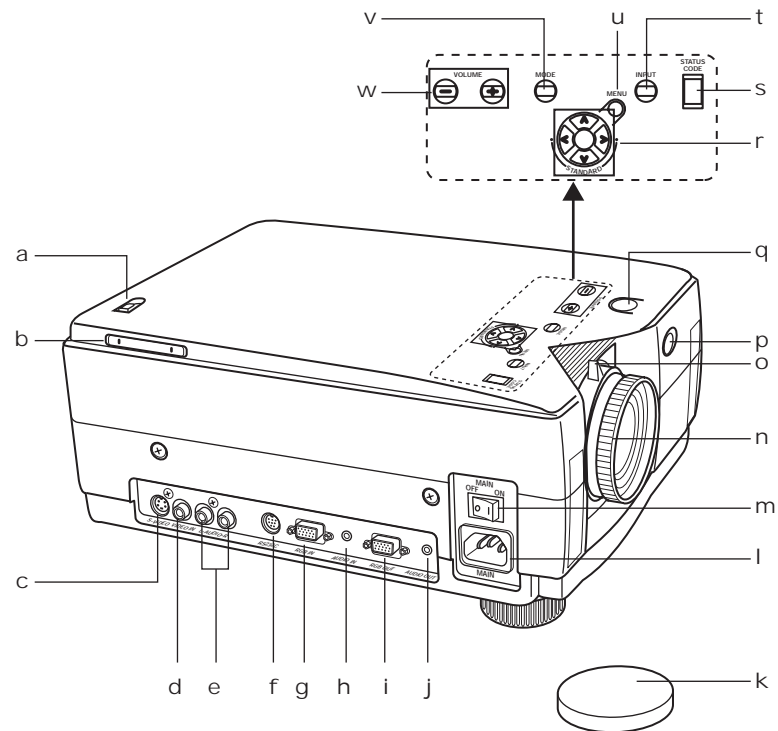

- | | |
|--------------------------------|---|
| a PC Card release button | m MAIN power switch |
| b PC Card slot | n FOCUS ring |
| c S-VIDEO input connector | o ZOOM ring |
| d VIDEO input connector | p Remote control sensor |
| e AUDIO (l/r) input connectors | q POWER button/ STANDBY(R)
ON(G) indicator |
| f RS-232C connector | r Adjust ▲/▼/◀/▶ buttons |
| g RGB input connector | s STATUS CODE |
| h Audio input connector | t INPUT button |
| i RGB output connector | u MENU button |
| j Audio output connector | v MODE button |
| k Lens cap | w VOLUME button |
| l AC socket (100-240V) | |

**LCD projector back/
bottom**

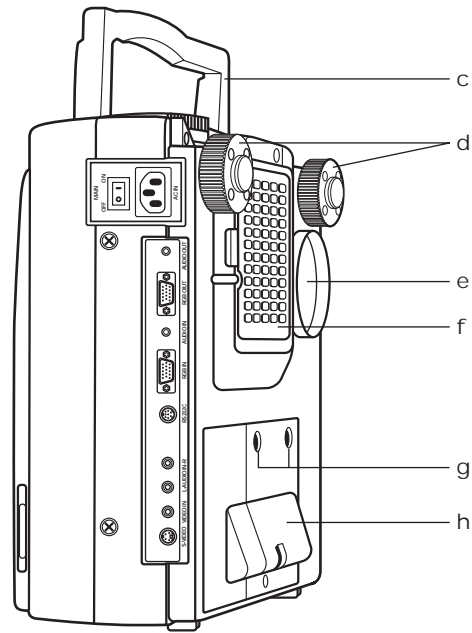
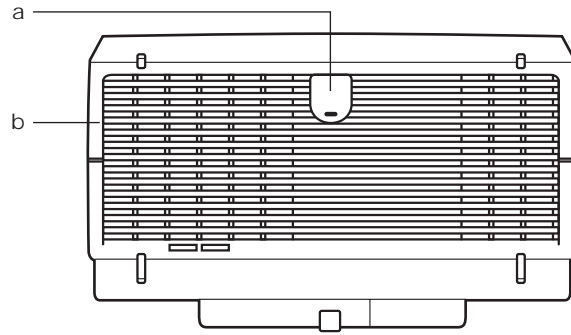

- | | |
|-------------------------|---------------------|
| a Remote control sensor | e Lens cap holder |
| b Air outlet port | f Air filter |
| c Carrying handle | g Lamp cover screws |
| d Adjusters | h Lamp cover |

Getting started

How to use the remote control unit

You can use the remote control unit in place of the computer's mouse.

Note: If PC-Card or Video mode is selected as the input signal mode for the LCD projector, the ProMouse feature cannot be used. (This includes the Pointer, Stamp and Line functions.)

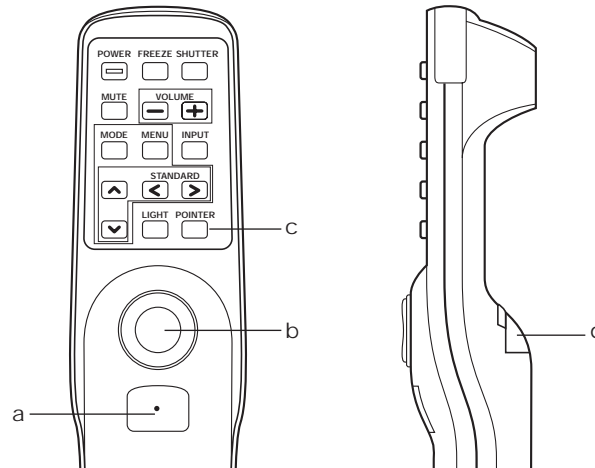

a Click 2 button

b Mouse button

c Pointer button

d Click 1 button

POINTER button: Each press will change the mouse cursor mode as shown below.

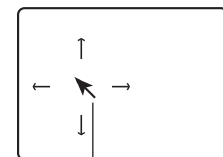
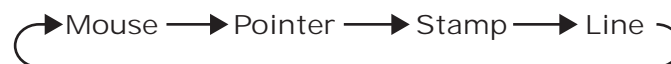

cursor button

Mouse button: This can be used in place of the computer's mouse pointing device to move the screen cursor.

Click 1 button: This button corresponds to the button on a single-button mouse, or to the left button on a standard mouse with two buttons.

- When this button is pressed in Stamp mode, you can mark the screen with a stamp.
- When this button is held down and used with the mouse button in Line mode, you can paint a line on the screen.

Click 2 button: This button corresponds to the right button on a standard mouse with two buttons.

- When in mouse cursor mode (Pointer, Stamp, or Line), you can return to mouse mode by pressing this button.

Setting up the LCD projector

Place the LCD projector on a stable, flat surface according to the LCD projector/screen relative position chart on page 32.

Positioning the LCD projector

Caution: Depending on the relative position of the LCD projector and the screen, improper adjustments may cause picture distortion. To prevent the LCD from wobbling, make sure both adjusters (see below) are in firm contact with the support surface.

Side view

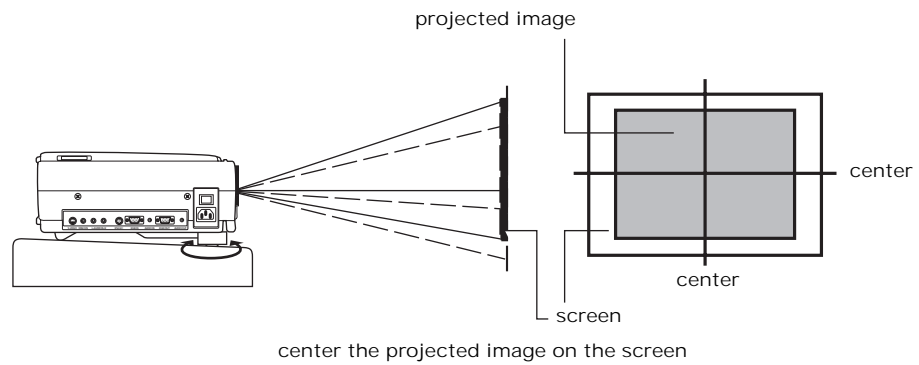

- - - - - Original picture position
- Picture position after adjustment

Front view

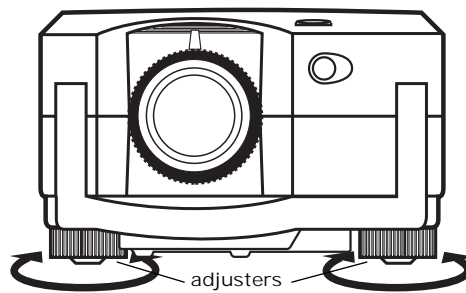

To raise the projector, turn the adjusters to the right.

To lower the projector, turn the adjusters to the left.

Note: For a distortion-free picture, it is very important that the LCD projector be positioned so that it is perfectly horizontal. If necessary, turn the adjusters in either direction to make fine adjustments.

Adjusting the lens

If the LCD projector is not set up so that it is horizontal, it will not be possible to obtain a distortion-free picture. Turn the adjusters in either direction to make fine adjustments to the level of the projector so that the projector is perfectly horizontal.

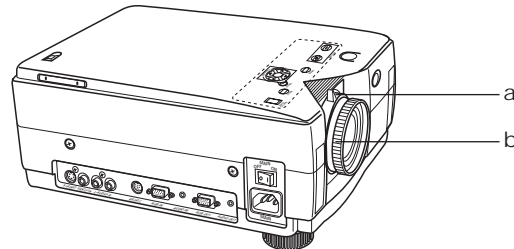

- a. Use the ZOOM ring to adjust the size of the picture.

For a larger picture, turn the ring to the right. For a smaller picture, turn the ring to the left.

- b. Use the FOCUS ring to adjust the focus of the picture.

Turn the ring to the right or left until the picture is at the optimum focus.

Rear screen mode projection

The image can be flipped to a mirror image of the input video signal for rear screen projection.

The procedure and on-screen displays shown below assume that an RGB signal is being used to input the signal.

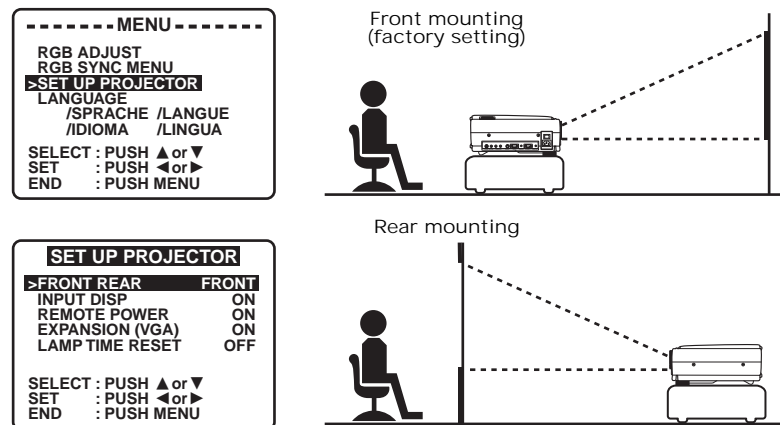

1. **Press MENU** to display the menu.
2. **Press ▲ or ▼** to select **SET UP PROJECTOR**, and then press **◀ or ▶** to display the screen.
3. **Press ▲ or ▼** to select **FRONT REAR** and then press **◀ or ▶** select **FRONT** or **REAR**.
Select **FRONT** to return to the standard projection format.
Select **REAR** to flip to a mirror image of the input signal.
4. **Press MENU** twice to exit.

Connecting the LCD projector

Before you begin

- Turn off the power supply of each system component before connecting any of the components.
- If necessary cables for connecting any of the system components are not supplied with the component or available as an optional accessory, you may need to obtain them yourself.

Connecting to a computer (RGB signal)

Diagram numbers correspond to the numbers in the computer cables & adapters chart. (see page 22).

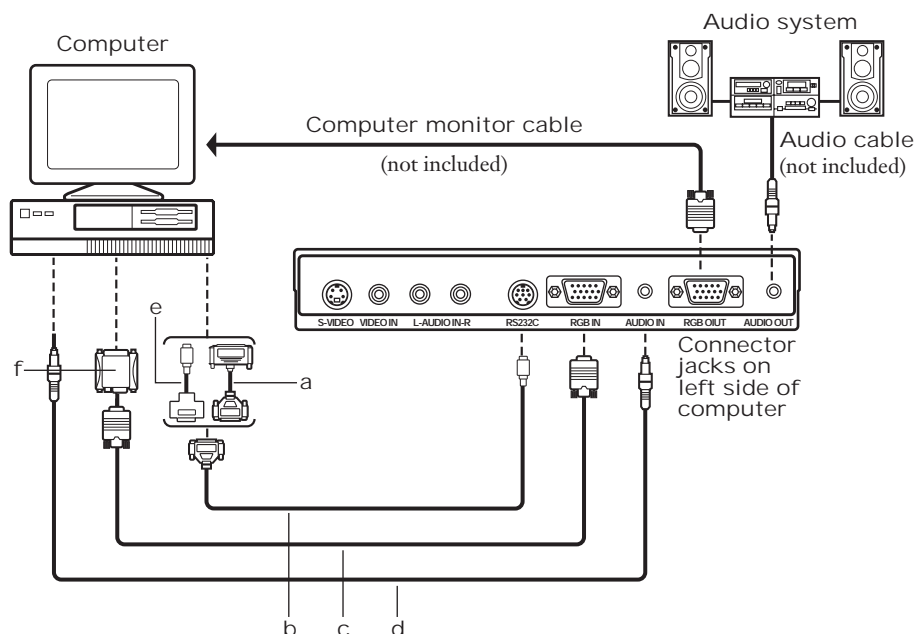

- | | |
|------------------------------|-----------------------------|
| a RS-232C 25-pin adapter (6) | d PC audio cable (3) |
| b RS-232C cable (4) | e RS-232C 9-pin adapter (5) |
| c VGA cable (1) | f VGA Mac adapter (2) |

Note:

- The RGB input accepts signals from VGA, SVGA, XGA (Compression), and MAC compatible computers without the need for any additional hardware.
- Plug the VGA signal cable (supplied) correctly into the RGB IN terminal on the LCD projector and the RGB signal output terminal on your computer. Secure the plugs by tightening the thumb screws.

When connecting the LCD projector to a Macintosh series computer, first connect the VGA/MAC adapter (supplied) to the RGB signal input terminal on your computer. Then, firmly plug the VGA signal cable into both the RGB IN terminal on the LCD projector and the VGA/MAC adapter on the computer. Secure the plugs by tightening the thumb screws.

- To view images simultaneously on the monitor and projection screen, connect your computer monitor to the LCD projector's RGB OUT terminal.
- When the LCD projector is connected to external devices (for example, a personal computer) you can use the remote control unit in place of the computer's mouse by attaching the RS-232C connector cable.

- Plug the RS-232C cable (supplied) correctly into both the RS-232C terminal on the LCD projector and the RS-232C output terminal on the computer. Secure the plugs by tightening the thumb screws.

When connecting to a Macintosh series computer, use the RS-232C 9-pin adapter (supplied). Or, when connecting to an IBM-PC series computer, use the RS-232C 25-pin adapter (supplied). Connect one of these RS-232C adapters to the RS-232C input terminal on your computer. Then, firmly plug the RS-232C cable into both the RS-232C terminal on the LCD projector and the RS-232C adapter on the computer. Secure the plugs by tightening the thumb screws.

- When connecting the LCD projector to a computer other than a VGA, SVGA, XGA (Compression), or Macintosh series, a separate cable is needed.
- If you wish to use the plug & play function, turn on the MAIN POWER switch on the LCD projector before turning on the computer.

**Connecting to audio/
video output
equipment
(S-VIDEO/VIDEO
signal)**

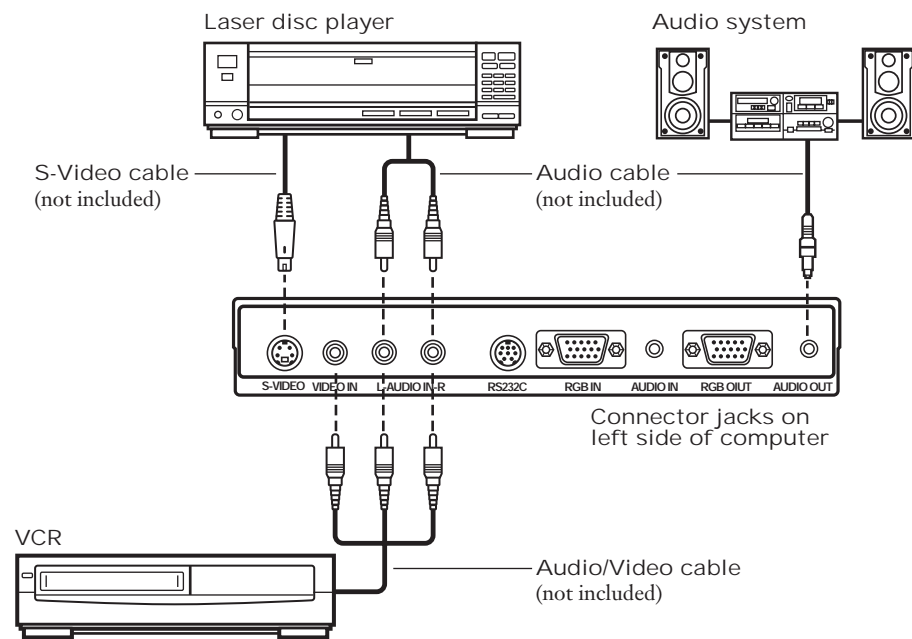











Note:

If the S-VIDEO IN and VIDEO IN terminals are both connected, the S-VIDEO IN signal input will have priority. To view the signal being input to the VIDEO IN terminal, disconnect the plug from the S-VIDEO IN terminal.

If the video signal source is connected using a cable with a BNC junction plug, use the BNC/RCA adapter (not included) to convert the pin jack.

Computer cables & adapters

These accessories are supplied in order to connect the LCD projector to computer equipment. The numbers in the left column correspond to the numbers in the connection diagram on page 20.

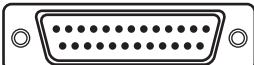
No.	Cable/adaptor	Port		Length
		Projector	Computer/AV product	
1	VGA cable	D-Sub HD 15-pin (male) 	D-Sub HD 15-pin (male) 	6.56 ft (2.0 m)
2	Macintosh – VGA adapter	D-Sub HD 15-pin (female) 	Macintosh D-Sub 15-pin (male) 	—
3	PC audio cable	M3 stereo mini-pin 	M3 stereo mini-pin 	6.56 ft (2.0 m)
4	RS-232C cable	Mini DIN 8-pin (male) 	D-Sub 9-pin (female) 	6.56 ft (2.0 m)
5	RS-232C 9-pin adapter	D-Sub 9-pin (male) 	Mini DIN 8-pin (female) 	—
6	RS-232C 25-pin adapter	D-Sub 9-pin (male) 	D-Sub 25-pin (female) 	—

Pin assignments

Follow the instructions below when connecting to a computer. Refer to page 22 for a list of cables and adapters.

- a. **Signal connector:** D-Sub HD 15-pin (PC/AT compatible model)
Connect the signal cable to the D-Sub HD 15-pin connector on the LCD project unit.
- b. **Signal connector:** D-Sub 15-pin (MAC) to convert a MAC D-Sub 15-pin connector to a D-Sub HD 15-pin connector, connect a VGA-MAC adapter (included) to the D-Sub 15-pin connector and then to the D-Sub HD 15-pin connector on the LCD projector. Be sure to set the DIP switches on the VGA-MAC adapter to your display type. (See “Setting the DIP Switches” on page 24)

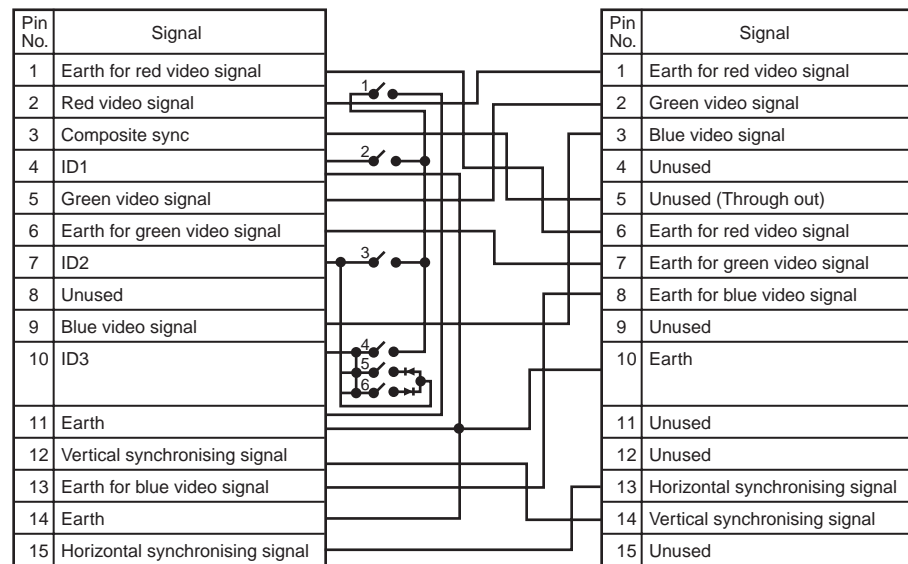

Note: When using a Composite Sync Output type Macintosh, please use a Composite Sync type VGA MAC adapter (pin 3 and pin 13 are connected).

Setting the DIP Switches

Find the resolution of your display type on the table shown at left (also on the adapter). Then, set each DIP switch that is indicated by a “●” mark to ON.

RESOLUTION	DIP SWITCHES					
	1	2	3	4	5	6
*21" MULTIMODE	●	●				●
*17" MULTIMODE	●	●			●	●
*13" MULTIMODE	●	●			●	●
VGA/SVGA MODE			●	●		
21" 1152X870	●	●	●			
19" 1024X768		●	●			
16" 832X624		●		●		
13" 640X480	●	●				

LEGEND:
 * = SUPPORTS APPLE MULTIPLE SCAN SOFTWARE
 ● = ON

Example: If your display type is 16", set DIP switches 2 and 4 on the VGA-MAC adapter to ON. By doing so, the signal will travel through switches 2 and 4 and pin numbers 4 to 10 as shown in the signal chart above.

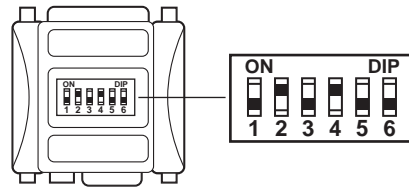

- c. **RS-232C connector:** D-Sub 9 pin Connect the RS-232C cable to the Mini DIN 8-pin connector on the LCD projector unit.
- d. **RS-232C connector:** Mini DIN 8-pin
To convert a D-Sub 9-pin connector to a Mini DIN 8-pin connector, use a RS-232C 9-pin adapter (included). Connect the D-Sub 9-pin adapter and RS-232C cable. Then, connect it to the Mini DIN 8-pin connector on the LCD projector unit.

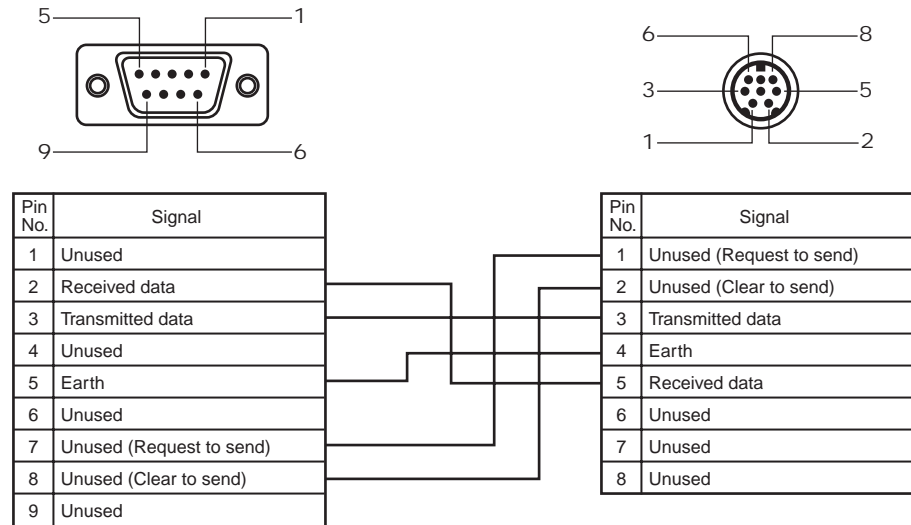

- e. **RS-232C connector:** D-Sub 25-pin
To convert a D-Sub 25-pin connector to a D-Sub 9-pin connector, use a RS-232C 25-pin adapter (included). Connect the D-Sub 25-pin adapter and RS-232C cable. And then connect it to the D-Sub 9-pin connector on the LCD projector unit.

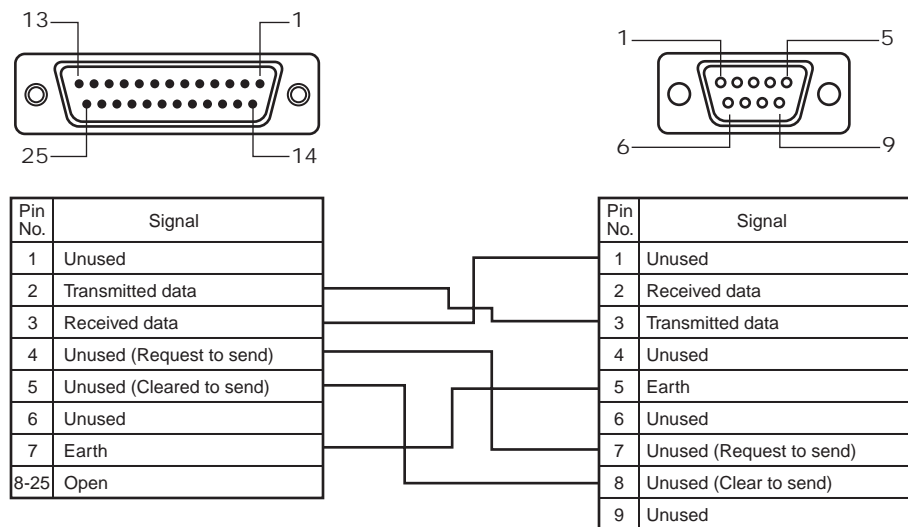

Factory preset timing

	Preset timing		
	IBM 640x350 at 70 Hz	IBM 640x400 at 70 HZ	IBM 640x480 at 60 Hz
Dot Clock	25.1745 Mhz	25.1745 Mhz	25.1745 Mhz
Horizontal frequency	31.4681 Khz	31.4681 Khz	31.4681 Khz
A-Period	31.778 μ s (800 dots)	31.778 μ s (800 dots)	31.778 μ s (800 dots)
B-Blanking	6.356 μ s (160 dots)	6.356 μ s (160 dots)	6.356 μ s (160 dots)
C-Sync Width	3.815 μ s (96 dots)	3.815 μ s (96 dots)	3.815 μ s (96 dots)
D-Back Porch	1.907 μ s (48 dots)	1.907 μ s (48 dots)	1.907 μ s (48 dots)
E-Active Time	25.423 μ s (640 dots)	25.423 μ s (640 dots)	25.423 μ s (640 dots)
F-Front Porch	0.636 μ s (16 dots)	0.636 μ s (16 dots)	0.636 μ s (16 dots)
Vertical frequency	70.0849 Hz	70.0849 Hz	59.939 Hz
A-Period	14.268 ms (449 lines)	14.268 ms (449 lines)	16.684 ms (525 lines)
B-Blanking	3.146 ms (99 lines)	1.5557 ms (49 lines)	1.430 ms (45 lines)
C-Sync Width	0.064 ms (2 lines)	0.064 ms (2 lines)	0.064 ms (2 lines)
D-Back Porch	1.907 ms (60 lines)	1.113 ms (35 lines)	1.049 ms (33 lines)
E-Active Time	11.122 ms (350 lines)	12.711 ms (400 lines)	15.254 ms (480 lines)
F-Front Porch	1.176 ms (37 lines)	0.381 ms (12 lines)	0.318 ms (10 lines)
Sync Polarity (H/V)	Positive/Negative	Negative/Positive	Negative/Negative

	Reservation timing	Preset timing	
	MAC LC 640x480	MAC II 640x480	VESA 640x350 at 85 Hz
Dot Clock	31.334 MHz	30.2410 MHz	31.5 MHz
Horizontal frequency	34.97 KHz	35.0012 KHz	37.861 KHz
A-Period	28.598 μ s (896 dots)	28.570 μ s (894 dots)	26.413 μ s (832 dots)
B-Blanking	8.171 μ s (256 dots)	7.407 μ s (224 dots)	6.095 μ s (192 dots)
C-Sync Width	2.043 μ s (64 dots)	2.803 μ s (63 dots)	2.032 μ s (64 dots)
D-Back Porch	2.426 μ s (76 dots)	3.241 μ s (98 dots)	3.048 μ s (96 dots)
E-Active Time	20.425 μ s (640 dots)	21.163 μ s (640 dots)	20.317 μ s (640 dots)
F-Front Porch	3.702 μ s (116 dots)	2.083 μ s (63 dots)	1.016 μ s (32 dots)
Vertical frequency	66.61 Hz	66.6689 Hz	85.080 Hz
A-Period	15.013 ms (525 lines)	15.000 ms (525 lines)	11.754 ms (445 lines)
B-Blanking	1.287 ms (45 lines)	1.286 ms (45 lines)	2.509 ms (95 lines)
C-Sync Width	0.086 ms (3 lines)	0.086 ms (3 lines)	0.079 ms (2 lines)
D-Back Porch	1.115 ms (39 lines)	1.114 ms (39 lines)	1.585 ms (60 lines)
E-Active Time	13.726 ms (480 lines)	13.714 ms (480 lines)	9.244 ms (350 lines)
F-Front Porch	0.886 ms (3 lines)	0.086 ms (3 lines)	0.845 ms (32 lines)
Sync Polarity (H/V)	Negative/Negative	Sync on Green or Composite	Positive/Negative

	Preset timing		
	VESA 640x480 at 85Hz	VESA 640x480 at 72Hz	VESA 640x480 at 75 Hz
Dot Clock	31.5 MHz	31.5 MHz	31.5 Mhz
Horizontal frequency	37.861 KHz	37.861 KHz	37.500 KHz
A-Period	26.413 μ s (832 dots)	26.413 μ s (832 dots)	26.667 μ s (840 dots)
B-Blanking	6.095 μ s (192 dots)	6.095 μ s (192 dots)	6.349 μ s (200 dots)
C-Sync Width	2.032 μ s (64 dots)	1.270 μ s (40 dots)	2.032 μ s (64 dots)
D-Back Porch	3.048 μ s (96 dots)	4.063 μ s (128 dots)	3.810 μ s (120 dots)
E-Active Time	20.317 μ s (640 dots)	20.317 μ s (640 dots)	20.317 μ s (640 dots)
F-Front Porch	1.016 μ s (32 dots)	0.762 μ s (24 dots)	0.508 μ s (16 dots)
Vertical frequency	85.080 Hz	72.8088 Hz	75.0000 Hz
A-Period	11.754 ms (445 lines)	13.735 ms (520 lines)	13.333 ms (500 lines)
B-Blanking	1.189 ms (45 lines)	1.057 ms (40 lines)	0.533 ms (20 lines)
C-Sync Width	0.079 ms (3 lines)	0.079 ms (3 lines)	0.080 ms (3 lines)
D-Back Porch	1.083 ms (41 lines)	0.740 ms (28 lines)	0.427 ms (16 lines)
E-Active Time	10.566 ms (400 lines)	12.678 ms (480 lines)	12.800 ms (480 lines)
F-Front Porch	0.026 ms (1 line)	0.238 ms (9 lines)	0.027 ms (1 line)
Sync Polarity (H/V)	Negative/Positive	Negative/Negative	Negative/Negative

	Preset timing		
	VESA 640x480 at 85Hz	VESA 800x600 at 56Hz	VESA 800x600 at 60Hz
Dot Clock	36.000 Mhz	36.000 Mhz	40.000 Mhz
Horizontal frequency	43.269 Khz	35.156 Khz	37.879 Khz
A-Period	23.111 μ s (832 dots)	28.444 μ s (1024 dots)	26.400 μ s (1056 dots)
B-Blanking	5.333 μ s (192 dots)	6.222 μ s (224 dots)	6.400 μ s (256 dots)
C-Sync Width	1.333 μ s (48 dots)	2.000 μ s (72 dots)	3.200 μ s (128 dots)
D-Back Porch	3.111 μ s (112 dots)	3.556 μ s (128 dots)	2.200 μ s (88 dots)
E-Active Time	17.778 μ s (640 dots)	22.222 μ s (800 dots)	20.000 μ s (800 dots)
F-Front Porch	0.889 μ s (32 dots)	0.667 μ s (24 dots)	1.000 μ s (40 dots)
Vertical frequency	85.008 Hz	56.250 Hz	60.317 Hz
A-Period	11.764 ms (509 lines)	17.778 ms (625 lines)	16.579 ms (628 lines)
B-Blanking	0.670 ms (29 lines)	0.711 ms (25 lines)	0.739 ms (28 lines)
C-Sync Width	0.069 ms (3 lines)	0.057 ms (2 lines)	0.106 ms (4 lines)
D-Back Porch	0.578 ms (25 lines)	0.626 ms (22 lines)	0.607 ms (23 lines)
E-Active Time	11.093 ms (480 lines)	17.067 ms (600 lines)	15.840 ms (600 lines)
F-Front Porch	0.023 ms (1 line)	0.028 ms (1 line)	0.026 ms (1 line)
Sync Polarity (H/V)	Negative/Negative	Positive/Positive	Positive/Positive

	Preset timing		
	VESA 800x600 at 72Hz	VESA 800x600 at 75Hz	VESA 800x600 at 85Hz
Dot Clock	50.000 Mhz	49.500 Mhz	56.250 Mhz
Horizontal frequency	48.077 KHz	46.875 KHz	53.674 KHz
A-Period	20.800 μ s (1040 dots)	21.333 μ s (1056 dots)	18.631 μ s (1048 dots)
B-Blanking	4.800 μ s (240 dots)	5.172 μ s (256 dots)	4.409 μ s (248 dots)
C-Sync Width	2.400 μ s (120 dots)	1.616 μ s (80 dots)	1.138 μ s (64 dots)
D-Back Porch	1.280 μ s (64 dots)	3.232 μ s (160 dots)	2.720 μ s (152 dots)
E-Active Time	16.000 μ s (800 dots)	16.162 μ s (800 dots)	14.222 μ s (800 dots)
F-Front Porch	1.120 μ s (56 dots)	0.323 μ s (16 dots)	0.569 μ s (32 dots)
Vertical frequency	72.188 Hz	75.000 Hz	85.061 Hz
A-Period	13.853 ms (666 lines)	13.333 ms (625 lines)	11.756 ms (631 lines)
B-Blanking	1.373 ms (66 lines)	0.533 ms (25 lines)	0.578 ms (28 lines)
C-Sync Width	0.125 ms (6 lines)	0.064 ms (3 lines)	0.056 ms (3 lines)
D-Back Porch	0.478 ms (23 lines)	0.448 ms (21 lines)	0.503 ms (27 lines)
E-Active Time	12.480 ms (600 lines)	12.800 ms (600 lines)	11.179 ms (600 lines)
F-Front Porch	0.770 ms (37 lines)	0.021 ms (1 line)	0.019 ms (1 line)
Sync Polarity (H/V)	Positive/Positive	Positive/Positive	Positive/Positive

	Preset timing (*Compression)		
	VESA 1024x768 at 60Hz	VESA 1024x768 at 70Hz	VESA 1024x768 at 75 Hz
Dot Clock	65.000 MHz	75.000 MHz	78.7500 Mhz
Horizontal frequency	48.363 KHz	56.476 KHz	60.0229 KHz
A-Period	20.677 μ s (1344 dots)	17.707 μ s (1328 dots)	16.660 μ s (1312 dots)
B-Blanking	4.923 μ s (320 dots)	4.054 μ s (304 dots)	3.657 μ s (288 dots)
C-Sync Width	2.092 μ s (136 dots)	1.813 μ s (136 dots)	1.219 μ s (96 dots)
D-Back Porch	2.462 μ s (160 dots)	1.920 μ s (144 dots)	2.235 μ s (176 dots)
E-Active Time	15.754 μ s (1024 dots)	13.653 μ s (1024 dots)	13.003 μ s (1024 dots)
F-Front Porch	0.369 μ s (24 dots)	0.320 μ s (24 dots)	0.203 μ s (16 dots)
Vertical frequency	60.004 Hz	70.069 Hz	75.0286 Hz
A-Period	16.666 ms (806 lines)	14.272 ms (806 lines)	13.328 ms (800 lines)
B-Blanking	0.786 ms (38 lines)	0.673 ms (38 lines)	0.533 ms (32 lines)
C-Sync Width	0.124 ms (6 lines)	0.106 ms (6 lines)	0.050 ms (3 lines)
D-Back Porch	0.600 ms (29 lines)	0.513 ms (29 lines)	0.466 ms (28 lines)
E-Active Time	15.880 ms (768 lines)	13.599 ms (768 lines)	12.795 ms (768 lines)
F-Front Porch	0.062 ms (3 lines)	0.053 ms (3 lines)	0.017 ms (1 line)
Sync Polarity (H/V)	Positive/Positive	Positive/Positive	Positive/Positive

*Note: Because some lines are omitted, picture degradation may occur.

	Preset timing (*Compression)	
	MAC 16" 832x624	MAC 19" 1024x768
Horizontal frequency	49.725 KHz	60.2410 KHz
A-Period	20.111 μ s (1152 dots)	16.600 μ s (1328 dots)
B-Blanking	5.587 μ s (320 dots)	3.800 μ s (304 dots)
C-Sync Width	1.117 μ s (64 dots)	1.200 μ s (96 dots))
D-Back Porch	3.910 μ s (244 dots)	2.200 μ s (176 dots)
E-Active Time	14.524 μ s (832 dots)	12.800 μ s (1024 dots)
F-Front Porch	0.559 μ s (32 dots)	0.400 μ s (4 dots)
Vertical frequency	74.550 Hz	74.9266 Hz
A-Period	13.414 ms (667 lines)	13.346 ms (804 lines)
B-Blanking	0.865 ms (43 lines)	0.597 ms (36 lines)
C-Sync Width	0.060 ms (3 lines)	0.050 ms (3 lines)
D-Back Porch	0.784 ms (39 lines)	0.498 (30 lines)
E-Active Time	12.549 ms (624 lines)	12.749 ms (768 lines)
F-Front Porch	0.020 ms (1 line)	0.050 ms (3 lines)
Sync Polarity (H/V)	Negative/Negative	—

**Note: Because some lines are omitted, picture degradation may occur.*

Turning the power on and off

If the MAIN power switch on the LCD projector is pressed while the cooling fan is still operating, the operating life of the projector lamp will be shortened. Be sure to follow the procedure outlined below when turning the LCD projector power supply on and off.

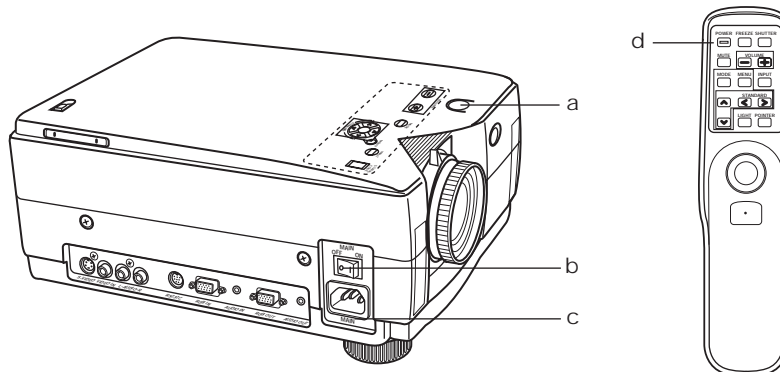

- a POWER button/STANDBY(R) ON(G) indicator
- b MAIN power switch
- c AC socket
- d POWER button (remote control)

Turning on the power

1. **Insert the power cord into the LCD projector AC socket and connect it to a properly grounded wall outlet.**
2. **Set the MAIN power switch on the LCD projector to ON.**

The STANDBY(R) ON(G) indicator lights red.

The first time you turn on the power, or whenever the STANDBY(R) ON(G) indicator is not lit, press the MAIN power switch (ON/OFF) to turn on the power.

3. **Press the POWER button on the LCD projector or remote control to turn on the power.**

The STANDBY(R) ON(G) indicator flashes green while the LCD projector is warming up, and then changes to solid green when the picture is projected on the screen after approximately 45 seconds.

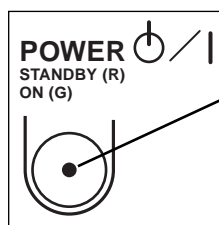

When the power is on, the STANDBY(R) ON(G) indicator indicates the operating condition of the lamp.

<i>Red</i>	MAIN power on (lamp off)
<i>Green</i>	Lamp is ready
<i>Flashing green</i>	Warming up
<i>Flashing red</i>	Cooling fan operating

Note: When POWER is first pressed, and while the LCD projector is warming up, the “Polaroid” letter will be projected on the screen for approximately 30 seconds. During the warm-up period, no other picture can be projected on the screen.

Turning off the power 1. **Press the POWER button on the LCD projector or remote control to turn off the power.**

The STANDBY(R) ON(G) indicator flashes red while the LCD projector cools down, and then changes to solid red when the fan stops after about a minute.

2. **Set the MAIN power switch on the LCD projector to OFF.**

Positioning the LCD projector and screen

The screen should be positioned so that it is not directly touched by sunlight or room light, as this will wash out the colors of the picture, making it hard to see. When possible, close all blinds and curtains and dim the lights. Also, the projector should be at a 90° angle to the screen for the best results. To determine the distance for the desired size, please refer to the LCD projector/relative screen position chart on page 32.

Top view

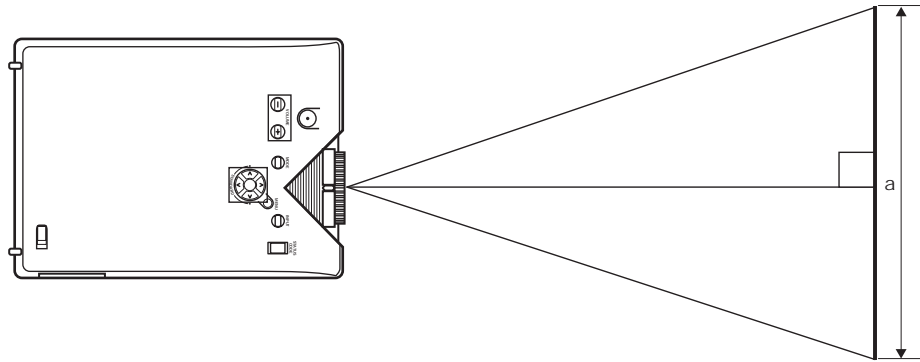

Side view

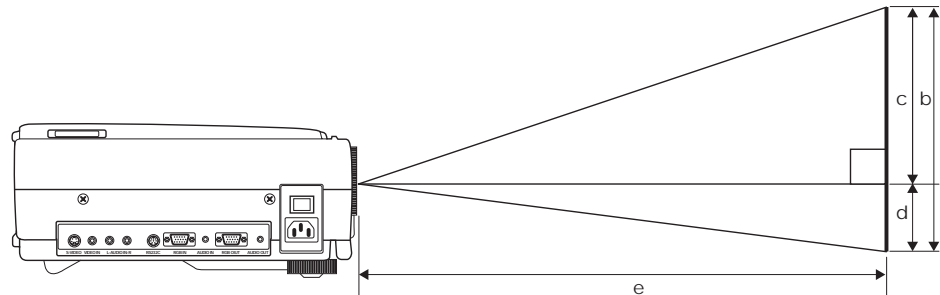

Your LCD projector is equipped with an image reverse feature. So, in addition to front projection, you can also reverse the image for rear projection. (See page 19)

LCD projector/screen relative position

The picture can be adjusted to the desired size within the range of the zoom lens. (This chart is based on SVGA input signals. Screen sizes will be smaller when VGA signals are used.)

Screen size	Throw distance (e)	Distance (a)	Distance (b)	Distance (c)	Distance (d)
20 inches	3.18 ft (0.97m)	1.35 ft (0.41m)	0.98 ft. (0.30m)	0.89 ft (0.27m)	1.18 ft (3cm)
40 inches	4.92-6.56 ft (1.5-2.0m)	2.66 ft (0.81m)	2.00 ft. (0.61m)	1.80 ft (0.55m)	2.36 ft (6cm)
60 inches	7.87-10.17 ft (2.4-3.1m)	3.94 ft (1.2m)	2.99 ft. (0.91m)	2.69 ft (0.82m)	3.54 ft (9cm)
72 inches	9.51-12.14 ft (2.9-3.7m)	4.92 ft (1.5m)	3.61 ft. (1.1m)	3.25 ft (0.99m)	4.33 ft (11cm)
80 inches	10.50-13.45 ft (3.2-4.1m)	5.25 ft (1.6m)	3.94 ft. (1.2m)	3.54 ft (1.08m)	4.72 ft (12cm)
100 inches	13.12-17.06 ft (4.0-5.2m)	6.56 ft (2.0m)	4.92 ft. (1.5m)	4.43 ft (1.35m)	5.91 ft (15cm)
120 inches	15.75-20.67 ft (4.8-6.3m)	7.87 ft (2.4m)	5.91 ft. (1.8m)	5.31 ft (1.62m)	7.09 ft (18cm)
150 inches	20.01-25.92 ft (6.1-7.9m)	9.84 ft (3.0m)	7.55 ft. (2.3m)	6.79 ft (2.07m)	9.06 ft (23cm)
200 inches	26.57-34.78 ft (8.1-10.6m)	13.45 ft (4.1m)	9.84 ft. (3.0m)	8.86 ft (2.7m)	11.81 ft (30cm)
250 inches	33.46-43.31 ft (10.2-13.2m)	16.73 ft (5.1m)	12.47 ft. (3.8m)	11.22 ft (3.42m)	14.96 ft (38cm)
300 inches	40.03-51.84 ft (12.2-15.8m)	20.01 ft (6.1m)	15.09 ft. (4.6m)	13.58 ft (4.14m)	18.11 ft (46cm)

If the LCD projector and the screen are not properly placed, the picture will be distorted producing a keystone image as shown at right.

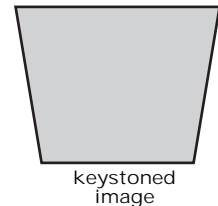

Caution: When setting up the LCD projector Do not place it in humid or dusty places, or places where the air is sooty or full of cigarette smoke. If the lens, mirror or other optical component becomes dirty, the picture will blur or darken, making viewing difficult.

Do not expose the projector to extreme heat or cold. Operating temperature: 41°-104°F (5°-40°C).

Basic LCD projector operation

Before you begin, make sure...

- You have read Important safeguards. (See page 7)
- All connections are made. (See page 20)
- The LCD projector is positioned properly. (See page 31)
- The LCD projector is plugged in.
- The lens cap is removed.

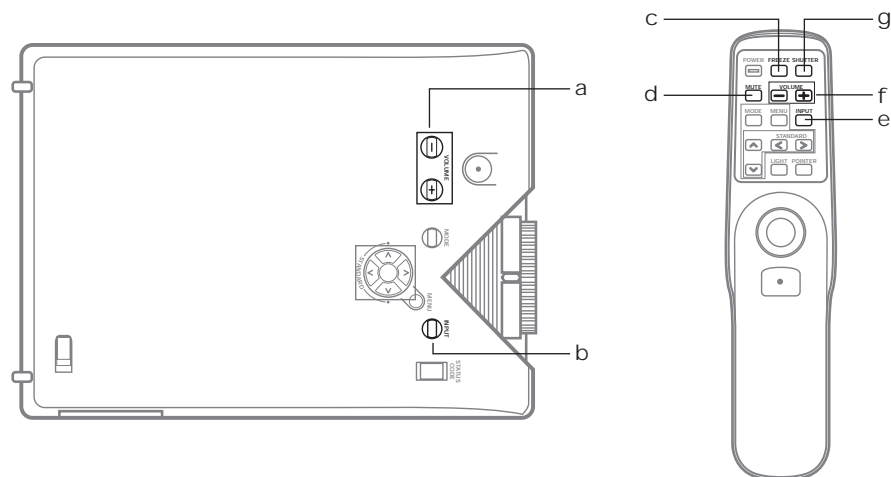

- | | |
|----------------------------------|--------------------------------------|
| a VOLUME +/- buttons | e INPUT button (remote control) |
| b INPUT button | f VOLUME +/- button (remote control) |
| c FREEZE button (remote control) | g SHUTTER button (remote control) |
| d MUTE button (remote control) | |

1. **Turn on the power.**
(See “Turning the power on and off” on page 30)
2. **Press INPUT on the LCD projector or remote control unit to select the desired input signal.**

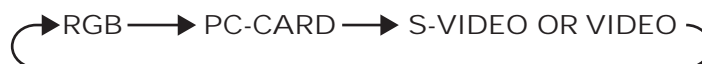

Continue to press INPUT to set the desired input signal. Each press will change the display as shown above.

You can turn the input signal display off. (See “Turning off the input signal display” on page 36.)

3. **Turn on your computer (RGB) or start video playback (S-VIDEO or VIDEO).**

Adjust FOCUS and ZOOM rings if necessary. (See “Adjusting the lens” on page 19)

4. **Press VOLUME +/- on the LCD projector or remote control unit to adjust the volume level of the built-in speaker.**

The number of segments (0-63) increases or decreases as the volume is adjusted.

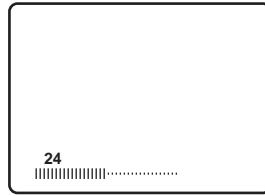

When you select an S-VIDEO or VIDEO input signal

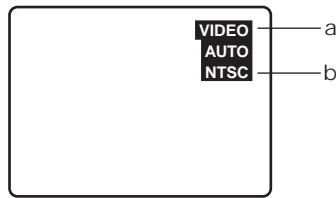

- a Input signal
- b Input signal format

Note: When an S-VIDEO or VIDEO input signal is selected, the name of the signal format will be displayed directly below the input signal in the on-screen display.

Special effects while projecting

- Turning off the sound
Press the MUTE button to instantly mute the sound.
Press again to restore the previous sound level.
- Manual shutter function
Press the SHUTTER button to blank out the video and mute the sound.
Press again to return to the normal screen and sound.
- Freezing the picture
Press the FREEZE button to freeze the picture and mute the sound.
Press again to return to the normal screen and sound.

Using other useful functions

You may use buttons on the LCD projector or remote control unit for the following operations.

Selecting the Language for On-Screen Displays (for Model PV215E-C only)

The LCD projector can display screens in one of five different languages. The procedure and on-screen displays shown below assume that an RGB signal is being used as the input signal.

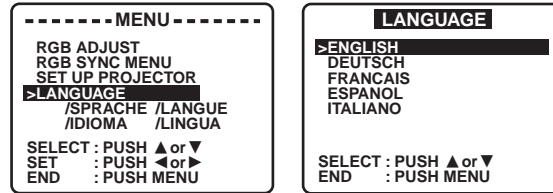

1. **Press MENU** to display the menu.
2. **Press ▲ or ▼** to select LANGUAGE, **and then press ◀ or ▶** to display the screen.
3. **Press ▲ or ▼** to select the language.
4. **Press MENU** twice to exit.

Selecting the Video System Format

The LCD projector is equipped with full NTSC, PAL, SECAM, PAL-M, PAL-N and NTSC4.43 video support. Usually set to AUTO, the broadcast format is automatically switched according to the tape inserted. If you experience poor color, however, you may have to set to NTSC, PAL, SECAM, PAL-M, PAL-N, or NTSC4.43 as described below.

S-VIDEO/VIDEO input is selected (page 34).

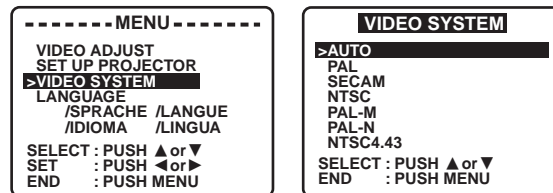

1. **Press MENU** to display the menu.
2. **Press ▲ or ▼** VIDEO SYSTEM, **and then press ◀ or ▶** to display the screen.
3. **Press ▲ or ▼** to select the desired video system.
4. **Press MENU** twice to exit.

Turning off the input signal display

The function which displays the currently selected input signal on the screen can be turned off by the following procedure. The procedure and on-screen displays shown below assume that an RGB signal is being used as the input signal.

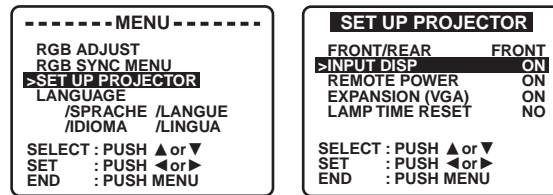

1. **Press MENU** to display the menu.
2. **Press ▲ or ▼** to select SET UP PROJECTOR, **and then press ◀ or ▶** to display the screen.
3. **Press ▲ or ▼** to select INPUT DISP, **and then press ◀ or ▶** to select ON or OFF.

Select OFF to turn off the input signal display function.

Select ON to turn on the input signal display function. The input signal will be displayed each time it is changed. (This is the factory setting.)

4. **Press MENU** twice to exit.

Disabling the POWER button on the remote control unit

In order to prevent the power from being turned off by mistake, the POWER button on the remote control unit can be disabled by the following procedure. The procedure and on-screen displays shown below assume that an RGB signal is being used as the input signal.

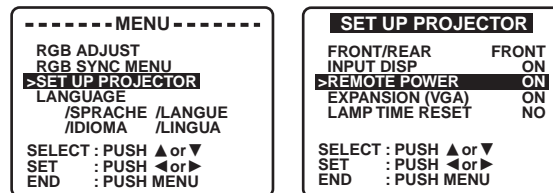

1. **Press MENU** to display the menu.
2. **Press ▲ or ▼** to select SET UP PROJECTOR, **and then press ◀ or ▶** to display the screen.
3. **Press ▲ or ▼** to select REMOTE POWER, **and then press ◀ or ▶** to select ON or OFF.

Select OFF to disable the POWER button on the remote control unit.

Select ON to use the POWER button on the remote control unit normally. (This is the factory setting.)

4. **Press MENU** twice to exit.

Canceling the enlarging (scanning line conversion) function

When a VIDEO/S-VIDEO signal in NTSC format or a signal with less than 800 x 600 dots (for example, 640x480 dots) is input, the LCD projector automatically enlarges the image to 800 x 600 dots. This may cause picture quality degradation. For a better image, select EXPANSION (VGA) or (NTSC):OFF by the following procedure.

The procedure and on-screen displays shown below assume that an RGB signal is being used as the input signal.

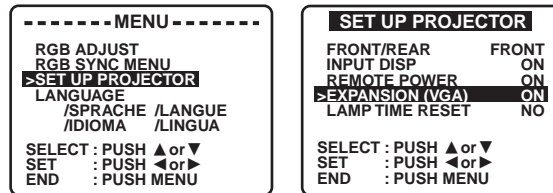

1. Press **MENU** to display the menu.
2. Press **▲ or ▼** to select **SET UP PROJECTOR**, and then press **◀ or ▶** to display the screen.
3. Press **▲ or ▼** to select **EXPANSION (VGA) OR (NTSC)**, and then press **◀ or ▶** to select **ON** or **OFF**.

Select **OFF** to cancel the enlarging (scanning line conversion) function.

Select **ON** to use the enlarging (scanning line conversion) function. (This is the factory setting.)

4. Press **MENU** twice to exit.

Changing to 16:9 (wide) screen format

When a VIDEO or S-VIDEO signal in NTSC format is input, the image can be displayed in 16:9 (wide) screen format by the following procedure.

S-VIDEO/VIDEO input is selected (page 34).

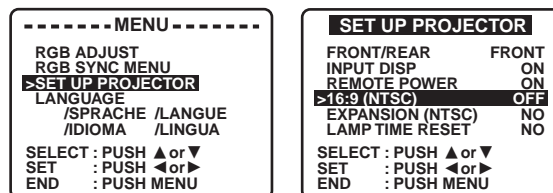

1. Press **MENU** to display the menu.
2. Press **▲ or ▼** to select **SET UP PROJECTOR**, and then press **◀ or ▶** to display the screen.
3. Press **▲ or ▼** to select **16:9 (NTSC)**, and then press **◀ or ▶** to select **ON** or **OFF**.

Select **OFF** to return the normal screen. (This is the factory setting.)

Select **ON** to display in 16:9 (wide) screen format.

4. Press **MENU** twice to exit.

Note: Even if the 16:9 (wide) screen feature is set to **OFF**, when an “S1” signal is input, the image is automatically displayed in 16:9 (wide) screen mode.

Blue Screen with no input signal

The LCD projector is equipped with an internal blue screen function which turns the screen blue when the video or computer equipment connected to the input jack is turned off, or when there is nothing connected to the input jack.

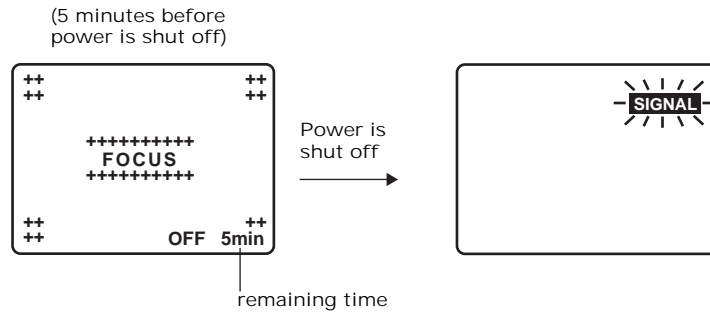

- If the power is turned on when no input signal is input to the LCD projector, the screen will turn blue.
The “FOCUS” overlay appears only until the video or computer equipment is connected to the input jack and turned on. If no input signal is received (the screen is blue) for 15 minutes, the lamp will turn off automatically.
- The display on the right in the above diagram will appear when the RGB input is within the LCD projector’s frequency range but is not one of the LCD projector’s programmed formats. (as on page 26 through page 29)
- Should an RGB signal be input which is out of the LCD projector’s frequency range, no indication will appear.

Adjusting the projected image

This LCD projector's picture is set to standard specifications at the factory. However, you can adjust the image to suit your own preferences by using the RGB or VIDEO ADJUST feature. Three memory modes allow you to adjust and save up to three sets of settings for each input signal (RGB and S-VIDEO/VIDEO).

For RGB signal input, three items can be adjusted: "BRIGHTNESS," "PICTURE," and "COLOR (White Balance)".

For VIDEO signal input, six items can be adjusted; "COLOR", "TINT", "BRIGHTNESS", "PICTURE", "SHARPNESS", and "SUB COLOR" (white balance).

Note: When a PC-Card is inserted, the RGB "BRIGHTNESS" memory is used. Only "BRIGHTNESS" can be adjusted.

Input image adjustment

RGB or S-VIDEO/VIDEO input is selected (page 33). Use the buttons on the LCD projector or remote control.

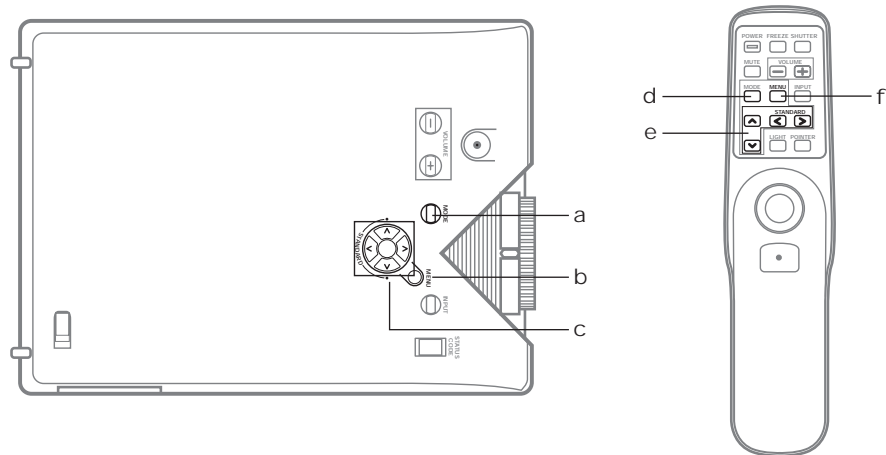

- a MODE button
- b MENU button
- c Adjust ▲/▼/◀/▶ buttons
- d MODE button (remote control)
- e Adjust ▲/▼/◀/▶ buttons (remote control)
- f MENU button (remote control)

1. **Press MENU** to display the menu.

RGB

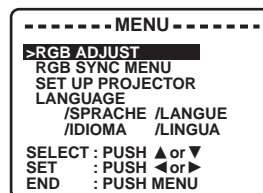

S-VIDEO/VIDEO

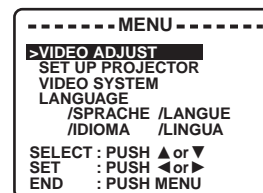

2. **Press ▲ or ▼ to select RGB ADJUST or VIDEO ADJUST, and then press ◀ or ▶ to display the screen.**

Three different sets of control adjustments can be memorized for different projection situations.

3. **Press MODE repeatedly** to choose one of the three memory modes for adjustment (page 45).

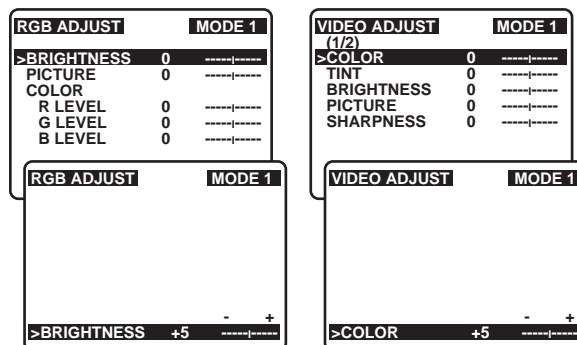

4. **Press ▲ or ▼ to select, and then press ◀ or ▶** to display the item to be adjusted.
5. **Press ◀ or ▶** to adjust as described below.
The setting will be displayed by numerals and a bar.
6. **Press MENU** once to return to the RGB ADJUST or VIDEO ADJUST menu, or three times to exit.

Adjustments for input image

- COLOR control (Adjust color intensity level.) (S-Video or video mode only)
Press ▶ to deepen the color.
Press ◀ to make the color paler.
- TINT control (Adjust hue for realistic tones.) (S-Video or video mode only)
Press ▶ for more green.
Press ◀ for more purple.
(Tint can be adjusted when the LCD projector is set to NTSC or NTSC4.43 video formats.)
- BRIGHTNESS control (Adjust black level to room brightness.)
Press ▶ to brighten the image.
Press ◀ to darken the background.
- PICTURE control (Adjust overall picture intensity.)
Press ▶ for a stronger picture.
Press ◀ for a fainter picture.
- SHARPNESS control (Adjust picture sharpness.) (S-Video or video mode only)
Press ▶ to sharpen the edges of the image.
Press ◀ to soften the edges of the image.
- COLOR or SUB COLOR (White Balance) control
See page 44 for details.

Recall standard settings

Press ◀ or ▶ together. If the menu showing all items is displayed, all items will be reset. If a single item is displayed, only that item will be reset.

RGB sync adjustment

For V POSI, H POSI, H SIZE and PHASE adjustments, see the PC Output Timing Relative Value Chart on page 43. These adjustments are carried out automatically when the Auto Setup feature of the ProMouse software is used. See “ProMouse Control Feature” on page 54.

RGB input is selected (See page 33). Use the buttons on the LCD projector or remote control unit.

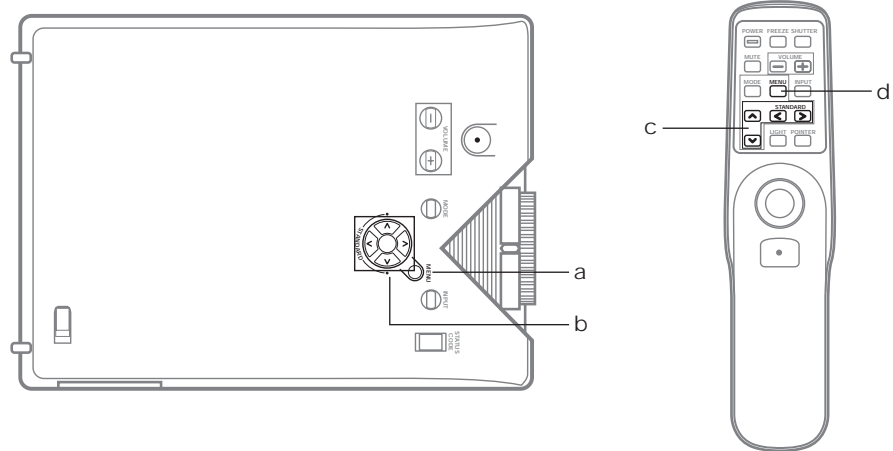

a MENU button

b Adjust ▲/▼/◀/▶ buttons

c MENU Button (remote control)

d Adjust ▲/▼/◀/▶ buttons (remote control)

1. **Press MENU** to display the menu.

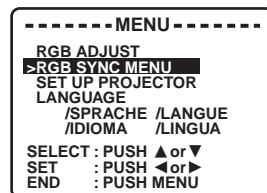

2. **Press ▲ or ▼ to select RGB SYNC MENU, and then press ◀ or ▶ to display the screen.**

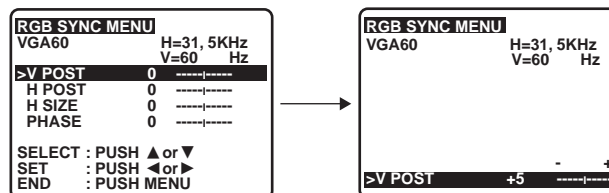

3. **Press ▲ or ▼ to select, and then press ◀ or ▶ to display the item to be adjusted.**

4. **Press ▲ or ▼** to adjust as described below.
The setting will be displayed by numerals and a bar.
5. **Press MENU** once to return to the RGB SYNC MENU menu, or three times to exit.

Adjustments for RGB input

- **V POSI (Vertical Position) Control**
(Adjust the vertical position within the projection screen.)
Press ◀ to move down or ▶ to move up.

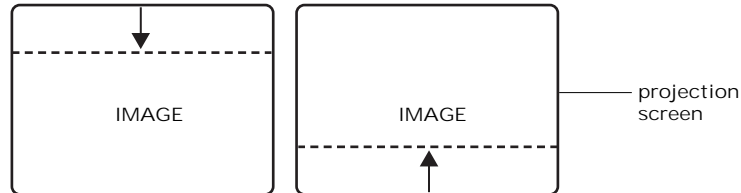

- **H POSI (Horizontal Position) Control**
(Adjust the horizontal position within the projection screen.)
Press ◀ to move left or ▶ to move right.

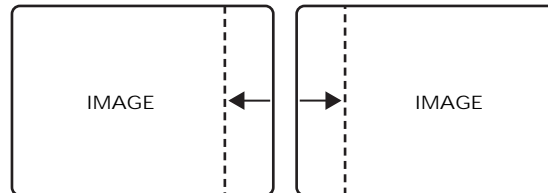

- **H (Horizontal) SIZE Control**
(Adjust the data display, timing, and attain the correct horizontal image size.)
Press ◀ or ▶ to eliminate the vertical stripes that appear on the computer screen.
- **PHASE Control**
(Adjust the vertical line strength so that text is readable.)
Press ◀ or ▶ to eliminate the flicker (localized noise) that appears on the computer screen.

PC Output Timing Relative Value Chart

Model	Vertical position	Horizontal position	Horizontal size
IBM 640 x 350 at 70 Hz/ IBM 640 x 350 at 70 Hz	-30+30	-50+50	-50+90
IBM 640 x 480 at 60 Hz	-30+30	-50+50	-50+90
MAC II 640 x 480	-30+30	-50+50	-50+90
MAC 16" 832 x 624	-30+30	-50+50	-50+90
VESA 640 x 350 at 85 Hz/ VESA 640 x 400 at 85 Hz	-30+30	-50+50	-50+90
VESA 640 x 480 at 72 Hz	-26+30	-50+50	-50+90
VESA 640 x 480 at 75 Hz	-14+30	-50+50	-50+90
VESA 640 x 480 at 85 Hz	-23+30	-50+50	-50+90
VESA 800 x 600 at 56 Hz	-19+30	-50+50	-50+90
VESA 800 x 600 at 60 Hz	-22+30	-50+50	-50+90
VESA 800 x 600 at 72 Hz	-24+30	-50+50	-50+90
VESA 800 x 600 at 75 Hz	-19+30	-50+50	-50+90
VESA 800 x 600 at 85 Hz	-25+30	-50+50	-50+90
VESA 1024 x 768 at 60 Hz	-30+30	-50+50	-50+90
VESA 1024 x 768 at 70 Hz	-30+30	-50+50	-50+90
VESA 1024 x 768 at 75 Hz	-29+30	-50+50	-50+90
MAC 19" 1024 x 768	-27+30	-50+50	-50+90

Adjusting the white balance

The picture may become over-saturated with red or blue color. Also, the white shade may not be the desired degree of whiteness. In such cases, you can adjust the white balance by the following procedure.

RGB input is selected (See page 33). Use the buttons on the LCD projector or remote control unit.

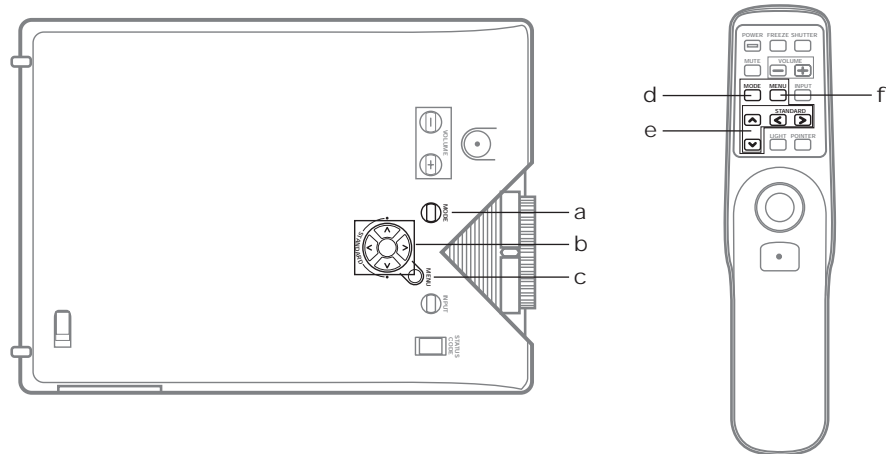

- a MODE button
- b Adjust ▲/▼/◀/▶ Buttons
- c MENU button
- d MODE button (remote control)
- e Adjust ▲/▼/◀/▶ buttons (remote control)
- f MENU button (remote control)

1. **Press MENU** to display the menu.
2. **Press ▲ or ▼ to select RGB ADJUST or VIDEO ADJUST, and then press ◀ or ▶** to display the screen.

3 different sets of control adjustments can be memorized for different projection situations.

RGB

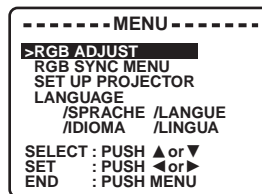

S-VIDEO/VIDEO

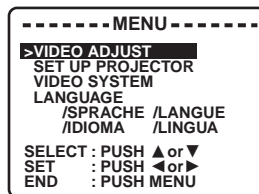

3. **Press MODE repeatedly** to choose one of the three memory modes for adjustment (page 45).

4. Press ▲ or ▼ to select R LEVEL, G LEVEL OR B LEVEL for the COLOR (for RGB input) or SUB COLOR (for S-VIDEO/VIDEO input).

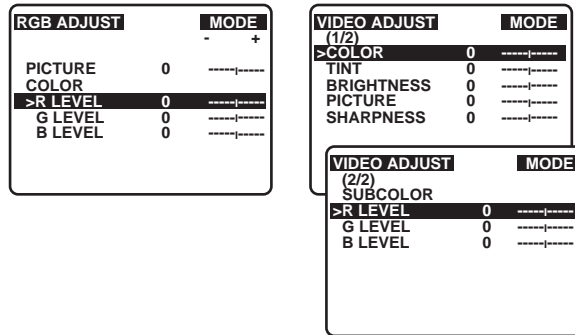

5. Press ◀ or ▶ to display the R, G or B LEVEL ADJUST screen.

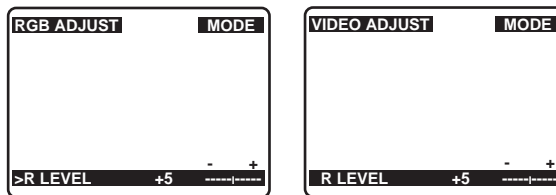

6. Press ◀ or ▶ to adjust the R, G or B Level.
The setting will be displayed by numerals and a bar.

Example of adjustment: R LEVEL

Press ▶ to strengthen the red component.

Press ◀ to weaken the red component.

7. Press MENU once to return to the RGB ADJUST or VIDEO ADJUST menu, or three times to exit.

Selecting the picture memory

Press MODE on the LCD projector or remote control unit to select the desired picture mode.

- When MODE is pressed, the preset setting will first be displayed on the screen for about 5 seconds.
- Each time you press MODE, the display will change as shown below:



Projecting PC-Card (ATA Flash Card) data

Using this software, “JPEG Viewer”, you can save the image displayed on the PC screen as a JPEG file to a PC-Card (ATA Flash Card). If you insert the PC-Card in this LCD projector, you can project using the JPEG Image Playback feature.

Follow the instructions below to use this feature.

Caution: It is possible that this feature will not operate correctly with all PC Cards. Operating performance of the following PC Card makers is verified. (ATA Flash Card). **Panasonic; Hitachi; TDK; SanDisk**

After purchasing a PC Card, perform (Normal) format with Windows 95 before using it.

Follow the instructions below when projecting image data saved on the PC-Card. (See “JPEG Viewer features” on page 48)

1. **Turn on the LCD projector to start projecting.** (See “Turning on the power” on page 30)
2. **Insert the PC-Card (2a) into the PC-Card slot (2b) on the LCD projector. Then, press INPUT on the LCD projector or remote control and select “PC-CARD”.**

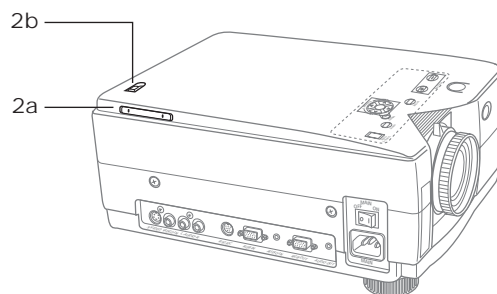

The INDEX and first image in each FOLDER are shown.

Note:

It takes a few seconds for the list of images to be displayed. (WAIT...appears) If you made JPEG files with something other than JPEG Viewer, it may take a much longer time to display the list of images.

See “When using BMP or JPEG → JPEG Converter feature”, and convert to JPEG files ideally suited to this LCD projector.

If you made a FOLDER with something other than JPEG Viewer, FOLDER-A, FOLDER-B,...will be displayed.

“ROOT” is displayed if images corresponding to this LCD projector are found in root directly.

The screen turns blue if images corresponding to this LCD projector are not found in the PC-Card.

When you want to eject the PC-Card, slide the PC-Card RELEASE button in the direction of the arrow mark on the LCD projector, and “NO CARD screen is displayed.

3. **Press ◀ or ▶ to select FOLDER.**
Press ▶ select the next FOLDER.
Press ◀ to select the previous FOLDER.

The selected FOLDER is indicated by a red arrow.

The selected image in FOLDER is encircled by a bold, blue frame.

Note: Press VOLUME to play back the first image of the selected FOLDER.

INDEX			
FOLDER 1			7
FOLDER 2			12
▶ FOLDER 3			24
FOLDER 4			5
FOLDER 5			13
FOLDER 6			11
SELECT FOLDER :		◀ or ▶	
TO SLIDE SHOW :		VOLUME-	
TO MULTI :		VOLUME+	

4. **Press VOLUME +** to decide FOLDER.

A list of images will be displayed.

5. **Press ◀ or ▶ to select an image.**

The selected image is encircled by a bold, blue frame, and the FOLDER name and number is displayed.

Note: Press ▲ or ▼ to change the selected FOLDER, and press VOLUME - to display the INDEX.

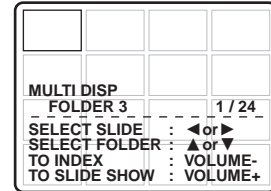

6. **Press VOLUME +** to project the selected image.

Press ◀ or ▶ select the images one by one.

Press ▶ to project the next image.

Press ◀ to project the previous image.

Note:

Press Volume - when playing back to return the screen to the list of images.

Press Volume + during playback to display the INDEX.

Press ▲ or ▼ during playback to display the file size and the operating instructions.

Press ▲ or ▼ again to turn off the display.

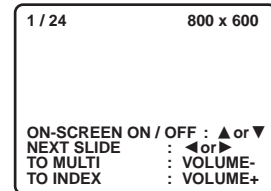

The LCD projector can automatically play back images one by one in the selected FOLDER, and you can select the length of time each image is played back.

1. **Press MENU** to display the menu.
2. **Press ▲ or ▼** to select "REPEAT PLAY".
3. **Press ◀ or ▶ repeatedly** to select the length of time each image is played back.

Playback length of 5 seconds, 10 seconds, 30 seconds, 60 seconds, or 120 seconds can be selected.

Note:

Repeat Play can only be used in the selected FOLDER.

You cannot select images while Repeat Play is in progress. Follow the above instructions to select REPEAT PLAY OFF, and then select an image.

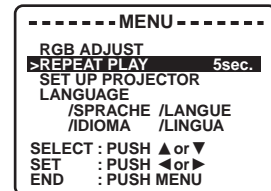
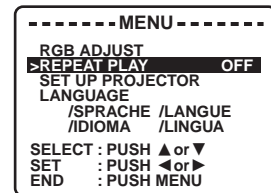

When using the Repeat Play

JPEG Viewer features

System requirements

- IBM PC/AT or compatible
- Microsoft Windows 95, Windows 98
- 16MB RAM or more recommended
- 2MB available hard disk space
- 3.5 inch 1.44MB floppy disk drive (for installation)
- PCMCIA Type II slot

JPEG Viewer installation

1. **Turn on the PC** and start up Windows 95 or 98.
2. **Insert the floppy disk** (JPEG Viewer software) into the floppy disk drive.
3. **Select [Run...]** from the Windows Start menu.
4. **Type in [A:\SETUP.EXE] and click [OK].**

It is assumed that your 3.5 inch 1.44MB floppy disk drive is assigned as drive "A". If not, replace "A" with the appropriate letter.



5. Follow the instructions as they appear on your PC screen.

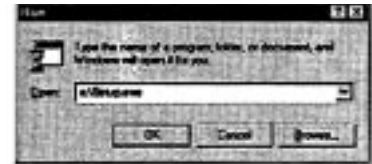

How to make JPEG files

You can make JPEG files using the installed JPEG Viewer software.

Capture feature

You can save captured images of your PC screen as JPEG files. (See page 51)

Note: Existing BMP or JPEG files must be converted and saved as JPEG files ideally suited to this LCD projector when projecting with this LCD projector. (See page 53)

Starting up the JPEG Viewer

Examples below assume the use of Windows 95.

1. **Turn on the PC** and start up Windows.
2. **Insert the PC-Card** (ATA Flash Card not supplied) into the PC-Card (a) Slot on your PC.

When you purchase a PC-Card, format it as you normally with Windows 95 or 98 before use.

3. **Select [Start] → [Programs] → [JPEG Viewer] → [JPEG Viewer]** to open the JPEG application.

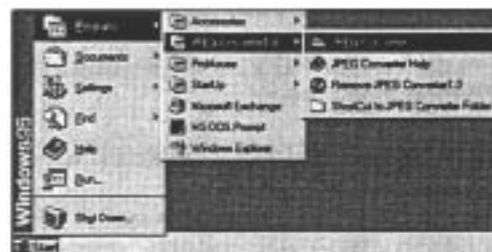
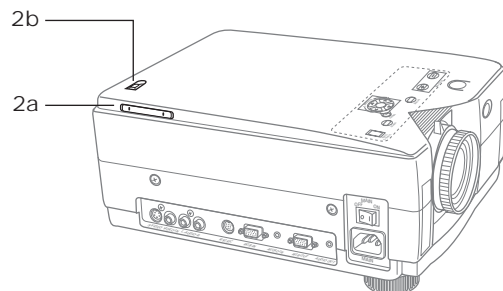

Functions of each menu item

Following are the software's menu items and their functions:

<u>F</u> ile	
<u>A</u> dd Graphic file to Folder	Converts an original BMP or JPEG file to a JPEG file and saves it to Folder
<u>D</u> elete Graphic file from Folder	Deletes selected images from Folder
<u>E</u> xit	Exits the JPEG Viewer
<u>F</u> older	
<u>N</u> ew	Makes new Folder
<u>O</u> pen	Opens saved Folder
<u>D</u> elete Folder	Deletes edited Folder
<u>T</u> ool	
<u>C</u> apture	Changes to the Capture mode
<u>R</u> emake Thumbnail	Remakes Thumbnail files of images contained in the edited folder
<u>O</u> ption	Sets the JPEG Viewer
<u>W</u> indow	
<u>C</u> ascade	Arranges windows in an overlapping pattern
Tile <u>H</u> orizontal	Arranges windows in a top to bottom pattern
Tile <u>V</u> ertical	Arranges windows in a left to right pattern
<u>A</u> rrange Icons	Arranges minimized windows
<u>H</u> elp	
JPEG Viewer <u>H</u> elp	Displays JPEG Viewer help
<u>V</u> ersion Information	Displays the version information

When using the Capture feature

1. **Select [Option] from the [Tool] menu, and then set the drive and JPEG quality for saving captured images.**

PC-Card drive

Select the PC-Card drive for saving images.

Wait time to start Capture

Set the waiting time from when the Capture is clicked until capturing the actual image starts. Select from 1 to 10 seconds.

JPEG quality

Set the picture quality of JPEG files to one of five levels. (Refer to Help for more details)

Note: The setting changes back to the default setting when the RESET button is clicked.



2. **Select [New] or [Open] from the [folder] menu, and then open Folder for saving images.**

Note:

The Folder is also opened if you click [New] or [Open] shortcut button on the Toolbar.

When creating a new Folder, a consecutive number is automatically assigned to the Folder name.

Folder1, Folder2...

Do not change the Folder name.



3. **Select [Capture] from the [Tool] menu to display the Capture dialog box.**

The dialogue box will also be displayed if you click [Capture] shortcut button on the Toolbar.

The Capture dialogue box is always displayed before other application screens, and the main window is minimized.

The file name (set in the Preference menu) followed by -1.jpg will be saved. Subsequent file names will be automatically assigned numbers up to 999 as long as the file name is not changed.

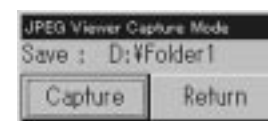

4. **Start up the PC application software and display the image you want to capture on the screen**
5. **Click [Capture] button in the Capture dialogue box. The displayed image will be saved to the selected Folder in JPEG format.**

Note:

The images in the capture dialogue box are not saved.

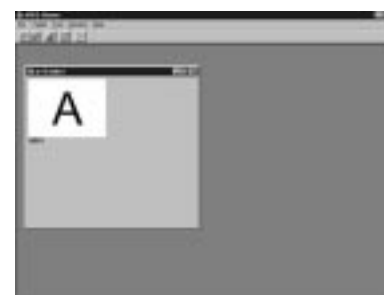

File names will automatically assigned consecutive numbers whenever saved, and thumbnail files will be made. Thumbnail files are used when displaying a list of images in this LCD projector or in this software.

JPEG file: Aut_0001.jpg, Aut_0002.jpg,...

Thumbnail file: Thm_0001.jpg, Thm_0002.jpg,....

Do not change these file names.

Pressing [Return] button in the Capture dialogue box will close this dialogue box. The main window will be displayed. The saved image will be displayed in the Folder.

Size of the projected screen

Because the projection image from this projector is SVGA (800x600 dots), an XGA image will be compressed.

If the picture file is less than VGA (640x480 dots) and the expanded projection feature is on, the picture will expand as follows: 640 → 800, 480 → 600.

For the best picture quality, it is recommended that JPEG files be 800x600 dots in size.

The larger the file size, the longer it will take (from when ◀ or ▶ is pressed) to project the picture.

How to edit using the Album Display feature

While confirming images displayed in an album, you can change the image display order and move images to another Folder using simple mouse operations.

Changing the image display order in Folder

1. **Select the image** you want to move.
2. **Drag the selected image and drop it into an image** in the desired location.

The selected image is inserted in front of the image it was dropped into.

The file name numbers are renewed automatically.

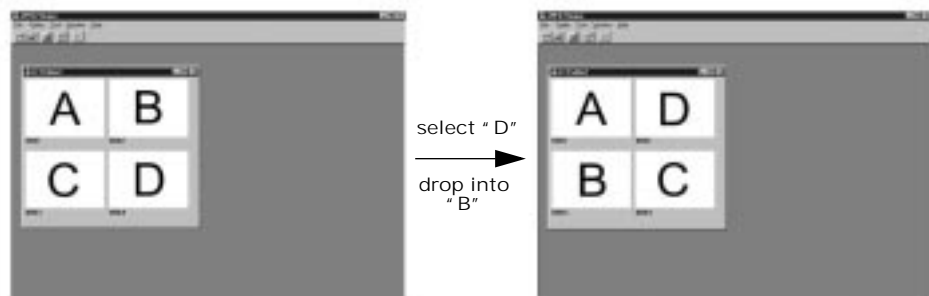

Moving the images between Folders

1. **Open the Folder** containing the image to be moved and the destination Folder.
2. **Select the image** that you want to move.

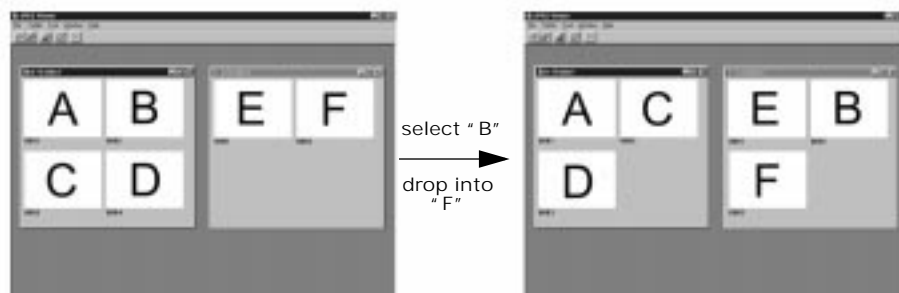

3. **Drag the selected image and drop it** into the destination Folder.
The selected image is inserted in front of the image that it was dropped into.
The file numbers are renewed automatically.

Displaying full-screen images for confirmation

1. **Double-click the image** that you want to confirm.

The image fills the entire screen.

Note: Click the mouse or press any button on the keyboard to return the screen to the Album display.

Deleting images

1. **Select the image** that you want to delete.
2. **Select [Delete Graphic file from Folder]** from [File] menu.

The image will be deleted from Folder.

Note: You can also delete the selected image if you press the [Delete Graphic file from Folder] shortcut button on the Toolbar.

When using the BMP to JPEG Converter feature

Note:

It is possible that the supplied software will not operate correctly, depending on the hardware configuration of the PC and the sharing of resources by other applications' software.

Specifications of these software are subject to change without notice.

1. **Select [Option] from the [Tool] menu, and set the drive and JPEG quality for saving converted images.**

PC-Card drive

Select the PC-Card drive for saving images.

JPEG quality

Set the picture quality of JPEG files to one of five levels. (Refer to Help for more details)



Note:

The setting changes back to the default setting when the RESET button is clicked.

2. **Select [New] or [Open] from the [Folder] menu, and then open Folder for saving images.**

The Folder is also opened if you click [New] or [Open] shortcut button on the Toolbar.

When creating a new Folder, a consecutive number is automatically assigned to the Folder name.

Folder1, Folder2...

Do not change the Folder name.

3. **Select [Add Graphic file to Folder] from the [File] menu, and designate the BMP (or JPEG) file that you want to convert.**

The JPEG Convert Status screen will appear and conversion will begin automatically.

The converted JPEG file is saved to the selected Folder.

Note:

File names will automatically assigned consecutive numbers whenever saved, and thumbnail files will be made. Thumbnail files are used when displaying a list of images in this LCD projector or in this software.

JPEG file: Aut_0001.jpg, Aut_0002.jpg,...

Thumbnail file: Thm_0001.jpg, Thm_0002.jpg,....

Do not change these file names.

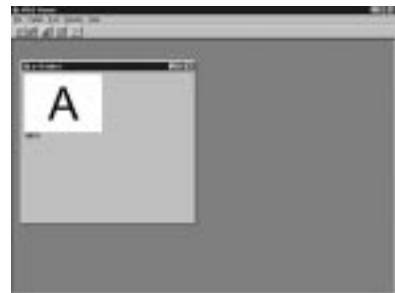
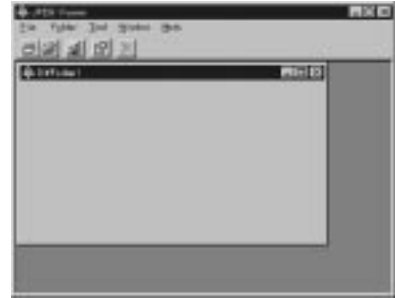

ProMouse Control Feature

This feature lets you use the LCD projector remote control unit as a mouse to control your personal computer. There is also an Auto Setup feature which identifies the signal mode and automatically adjusts the vertical position, horizontal position, horizontal size, and phase.

Windows 95 / Windows 98

System requirements

- IBM PC/AT or compatible
- Windows 95 or Windows 98
- 386SX CPU or higher
- 8MB RAM on-board memory
- 2MB available hard disk space
- 3.5 inch 1.44 MB floppy disk drive (for installation)

Note:

It is possible that the supplied software will not operate correctly, depending on the hardware configuration of the PC and the sharing of resources by other applications' software.

Specifications of these software are subject to change without notice.

ProMouse installation

1. **Turn on the PC** and start up Windows.
2. **Insert the floppy disk** (ProMouse software) into the floppy disk drive.
3. **Select [Run...] from the Windows Start menu**



4. **Type in [A:\SETUP.EXE] and click [OK].**

It is assumed that your 3.5 inch 1.44MB floppy disk drive is assigned as drive "A".
If not, replace "A" with the appropriate letter.

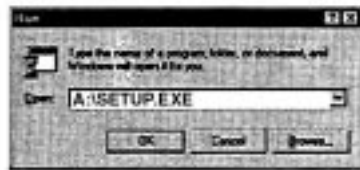

5. Follow the instructions as they appear on your PC screen.

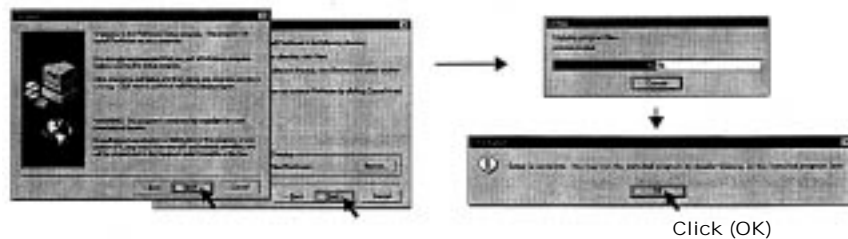
*To open the ProMouse Software*

Select [Programs] → [ProMouse] → [ProMouse] from the Windows Start Menu.



- The ProMouse Menu screen will appear.

Using the ProMouse Software

The setting window will appear when the ProMouse software is started up.

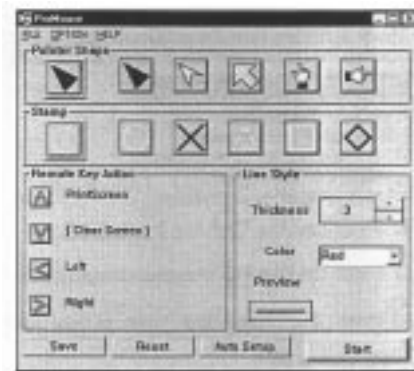

To start the ProMouse Control feature

Follow the steps below. Please refer to “ProMouse Software details” (below) for detailed settings.



1. **Select the Option → Communication Setting.**
Select and set COM1 or COM2.
2. **Click Start** in the lower right corner of the setting window. The ProMouse Control feature will start and the setting window will be minimized.

To Use the Auto Setup feature

The signal mode is identified and the vertical position, horizontal position, horizontal size, and phase are automatically adjusted. Click on Auto Setup at the bottom of the setting window.

- You may also select Option → Auto Setup.
- The on-screen display at right will appear during auto adjustment.
- Auto Setup may not be possible with some computer types.



ProMouse Software details

File Menu

- **Save**
Saves the current window status.
You may also click Save in the lower left corner of the setting window.
- **Exit**
Quits the ProMouse Control feature.

Option Menu

- Clear Screen
Deletes all the lines or stamp marks written on the screen.
- Mouse Setting
The dialog shown below will appear. Sets the movement speed of the mouse using the remote control unit.

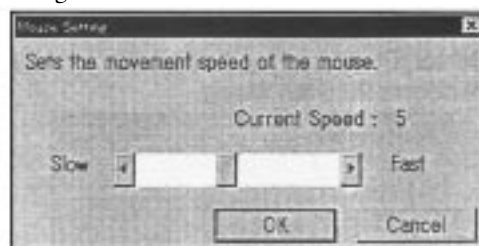

Help Menu

- Contents
Displays help information for the software.
- Version Information
Displays a dialogue box indicating the version of the software.

Window Setting

- Pointer Shape
Selects the indicating pointer mark on the screen.
The currently selected pointer mark appears at the left end of this row.
- Stamp
Selects the indicator stamp mark on the screen.
The currently selected stamp mark appears at the left end of this row.
- Remote Key Action
You can program the ▲, ▼, ◀, and ▶ keys as personal computer shortcut keys.

How to program

1. Click on the remote key you want to be programmed in the setting window.

The screen shown at right will appear.

2. Operate the desired shortcut command on the PC and click OK.

The key selected in step 1 will be programmed with the shortcut command operated in step 2.

Programmed shortcut keys are indicated in the setting window.

Because the Clear Screen command is necessary to delete lines or stamp marks from the screen, the ▼ key is programmed as Clear Screen at the factory. If you wish to change this command to a different key, follow steps (1) and (2).

- Line Style
Selects the indicating line thickness and colors on the screen.

Note: To return all items in the setting window to their original factory setting, click on Reset.

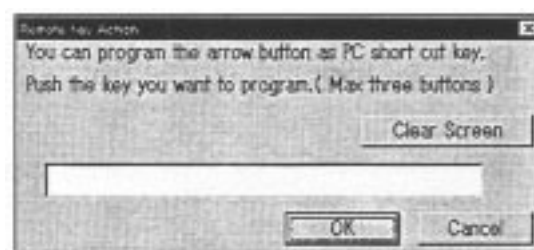

Macintosh

System requirements

- System 7.1 or later
- 68030 CPU or higher, or Power Macintosh
- 2 MB RAM on-board memory
- 2MB available hard disk space
- 3.5" 1.44MB floppy disk drive (for installation)
- Serial port (Mini DIN 8 pin)

Note:

It is possible that the supplied software will not operate correctly, depending on the hardware configuration of the personal computer and the sharing of resources by other applications' software.

Specifications of these software are subject to change without notice.

ProMouse installation

1. **Turn on the Macintosh.**
2. **Insert the floppy disk** (ProMouse software) into the floppy disk drive.
3. **Double click** the floppy disk ProMouse(E) icon.



4. **Double click** on the ProMouse(E) Installer icon.



5. **Select the installation method**, "Easy Install," "Custom Install" or "Remove".

- **Easy Install**

Lets ProMouse designed fat binary items run on the Macintosh hard disk.

- **Custom Install**

Lets you select the type of Macintosh.

- **Remove**

Removes installed ProMouse(E) software from the Macintosh hard disk.



6. **Click on "Install"** to start the ProMouse software installation.

7. **Click on “Restart”** to finish the installation and restart the Macintosh.

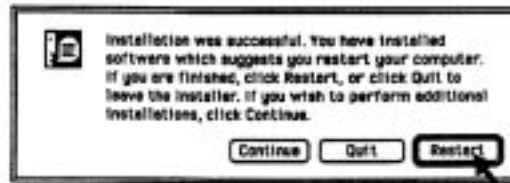

To open the ProMouse Software

Double click the ProMouse icon in the ProMouse Folder.



The ProMouse software will open.

Using ProMouse Software

The setting window will appear when the ProMouse software is started up.

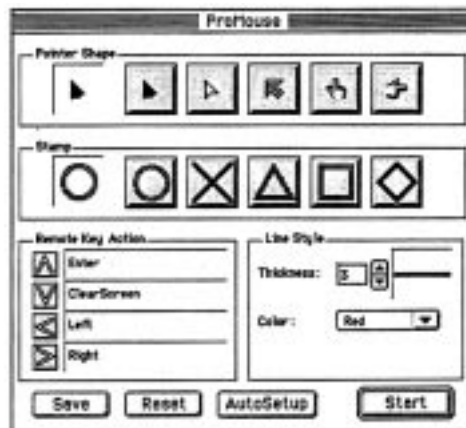

To start the ProMouse Control feature

Follow the steps below. Please refer to “ProMouse Software Details” (below) for detailed settings.

1. **Select the Option → Connection Setting.**

The dialogue box shown at right will appear.

2. **Select the Printer port or Modem port. Then click OK.**

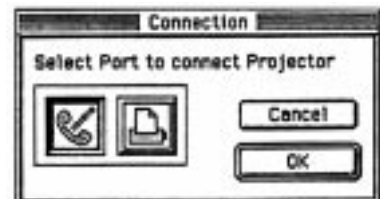

Refer to the Macintosh Operation Manual for details on the communication ports.

3. **Click on Start** in the lower right corner of the setting window.

The ProMouse Control feature will start and the setting window will be closed.

To Use the Auto Setup feature

The signal mode is identified and the vertical position, horizontal position, horizontal size, and phase are automatically adjusted. Click on Auto Setup at the bottom of the setting window.

- You may also select Option → Auto Setup.
- The on-screen display at right will appear during auto adjustment.
- Auto Setup may not be possible with some computer types.



ProMouse Software details

File Menu

- Save
Saves the current window status.
You may also click Save in the lower left corner of the setting window.
- Quit
Quits the ProMouse Control feature.

Option Menu

- Clear Screen
Deletes all the lines or stamp marks written on the screen.
- Mouse Setting
The dialog box shown at right will appear. Sets the movement speed of the mouse using the remote control unit.

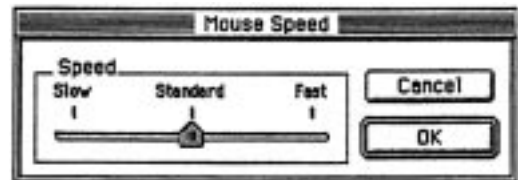

Apple Menu

- Version
Displays a dialogue box indicating the version of the software.

Window Setting

- Pointer Shape
Selects the indicating pointer mark on the screen.
The currently selected pointer mark appears at the left of this row.
- Stamp
Selects the indicator stamp mark on the screen.
The currently selected stamp mark appears at the left end of this row.
- Remote Key Action
You can program the ▲, ▼, ◀, and ▶ keys as personal computer shortcut keys.

How to program

1. Click on the remote key you want to be programmed in the setting window.

The screen shown at right will appear.



2. Operate the desired shortcut command on the PC.

The key selected in step 1 will be programmed with the shortcut command operated in step 2.

Programmed shortcut keys are indicated in the setting window.

Because the Clear Screen command is necessary to delete lines or stamp marks from the screen, the ▼ key is programmed as Clear Screen at the factory. If you wish to change this command to a different key, follow steps (1) and (2).

- Line Style
Selects the indicating line thickness and colors on the screen.

Note: To return all items in the setting window to their original factory setting, click on Reset.

Appendix

Maintenance

Warning Indications

Status Code Display Indications

This LCD projector has a STATUS CODE display that calls your attention to problem conditions existing inside the LCD projector. The LCD projector displays a status code indication each time an internal problem is detected. If any of the following indications appear in the STATUS CODE display, immediately turn off the MAIN power. Then, see the chart below.

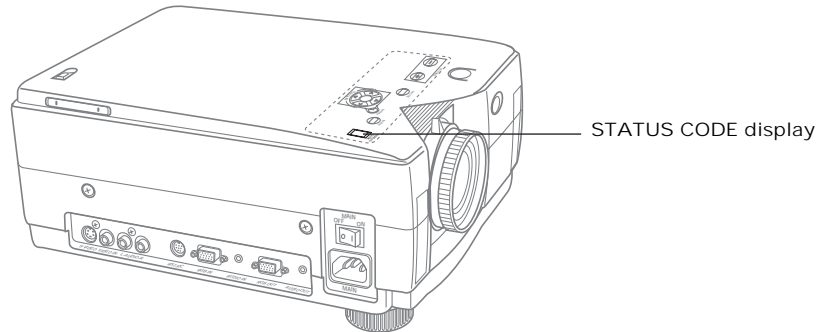

Status Code	Symptom	Problem	Possible Solution
F-L	Lamp unit automatically turns off due to abnormally high internal temperature. (Standby-by condition)	Cooling fan malfunction	Take the LCD projector to your nearest Service Center.
F-O		Misinstalled air filter unit.	Properly install the air filter unit.
A-n		Temperature sensor malfunction.	Take the LCD projector to your nearest Service Center.
A-0 A-1		Clogged air filter. Blocked air intake. The surrounding temperature of the place of use may be too high.	Clean the filter (See page 63). Relocate the projector to a proper location. Place the projector so that the surrounding temperature is between 5°C(41°C (104°F) and the humidity is between 10% and 80% (with no condensation).
L-n P-2	Lamp does not light up.	Lamp is burned out. Lamp voltage is not correct.	Take the LCD projector to your nearest Service Center.
P-3 P-4	Abnormally high internal temperature.	Abnormal temperature rise. Other cause.	

Status Code	Symptom	Problem	Possible Solution
L-1	Lamp operation time is over 1000 hours.	It is nearly time to replace the lamp unit.	Replace the lamp unit. (See page 66).
L-0	Lamp operation time is over 1100 hours.	The lamp unit must be replaced.	
C-d	Forced cooling fan operating to expedite lamp replacement (See page 65).	—	—

Note: Please wait one minute before turning the power back on, to allow the lamp to cool. A much longer time may be required if the LCD projector has reached an abnormally high internal temperature.

Cleaning the Air Filter

The air filter should be cleaned about every 100 hours. Also, clean the air filter if “A-0” appears in the STATUS CODE display.

Replace the filter when it is clogged or dirty even after cleaning.

Cleaning procedure

Tools required: Vacuum cleaner.

Wait until the cooling fan stops and the STANDBY(R) ON(G) indicator turns solid red.

1. **Set the MAIN power switch to OFF and unplug the power cord.**

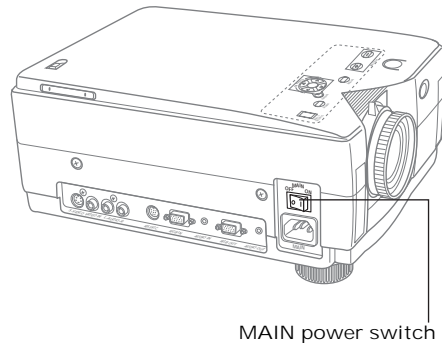

2. **Place the LCD projector up on its side as illustrated.**

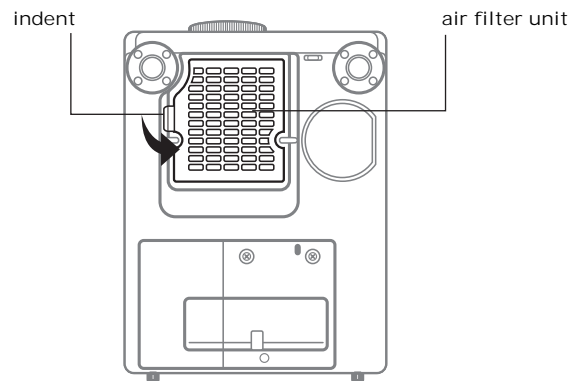

3. **Remove the air filter unit**

Hold the indent on the air filter unit with your hands and pull the air filter unit out of the LCD projector.

4. **Clean the filter.**

Gently remove any accumulated dust from the air filter unit with your vacuum cleaner.



Caution: Operating the LCD projector with a torn or damaged air filter may cause damage to the LCD projector.

5. **Replace the air filter unit.**

Slide the air filter unit into the LCD projector until the hollows in the air filter unit are aligned with the hollows in the LCD projector.

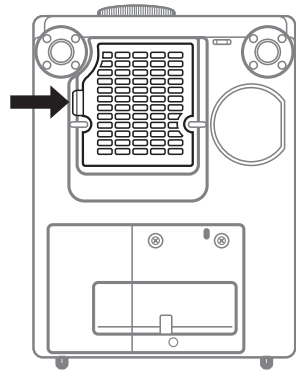

Note: The LCD projector power cannot be turned on unless the air filter unit is correctly installed.

Lamp Replacement

Warning: If Status Code "L-n" (see page 62) is displayed on the Status Code Display when lamp is not turned on, take the LCD Projector to your nearest Service Center for repair as there is danger of injury due to lamp fragments.

Lamp replacement period

The LCD projector lamp has a limited operating life of approximately 1100 hours.

"LAMP TIME REMAINING 10h" will be displayed on screen when the operation time reaches 1090 hours. Then, each time the power is turned on, the lamp life remaining will be displayed.

A 10-second warning display (15 seconds when the LCD projector power is turned on) will appear every hour after 1090 hours of operation time, and the warning will flash during the last 5 minutes of lamp life.

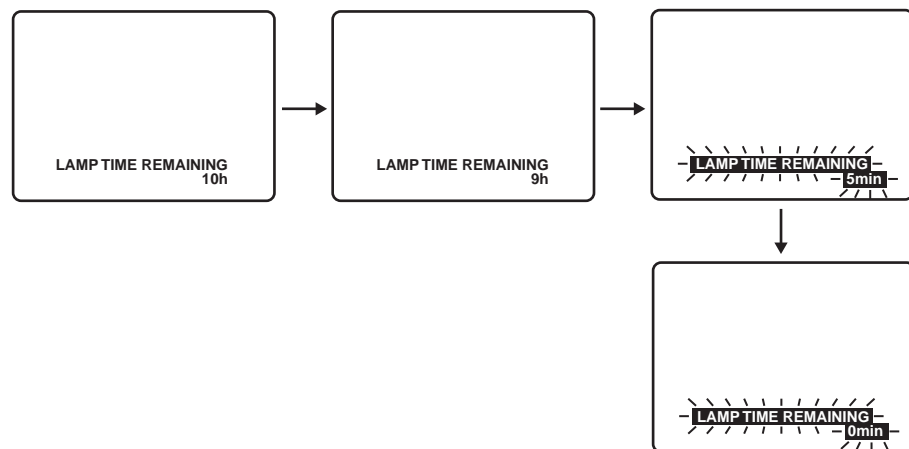

If lamp use reaches 1100 hours

The LCD projector will shut itself off and the STATUS CODE indication will become "L-0". (See STATUS CODE on page 62.)

1. Replace the lamp.
2. Press POWER ON, the "Lamp Time Reset" display will appear to reset the lamp time.
 - Only this screen will be displayed when POWER is pressed until the lamp time is reset. (The LCD projector cannot display a normal picture at this time.)
 - If the lamp time is not reset, this screen will disappear and the LCD projector will shut itself off after about 10 minutes.
3. Press ◀ or ▶ to select YES.
4. Turn the power off to reset the lamp time.

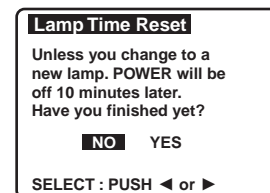

Lamp replacement procedure

Caution: Because of possibility of injury, strictly follow the lamp replacement procedure outlined below.

Order Lamp: 630146 Tools required: A coin.

1. **After the cooling fan has stopped and the STANDBY(R) ON(G) indicator turns solid red, set the MAIN power switch to OFF and unplug the power cord.**

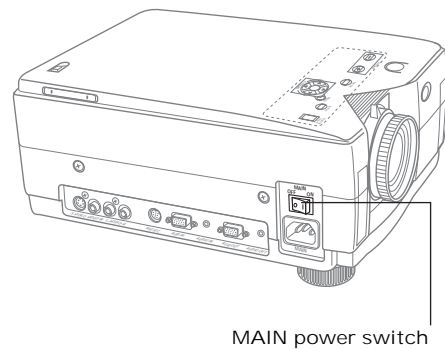

Note: Please wait more than one hour before replacing the lamp.

If you need to replace the lamp more urgently

1. The LCD Projector has a forced cooling feature. After the POWER switch is turned OFF, and sometime during the first minute of the cooling fan operation, press ◀ and ▶ at the same time. The cooling fan will change to high speed for about 10 minutes. (The “C-d” STATUS CODE will be displayed.)
2. **Grabbing the handle, place the LCD projector up on its side as illustrated.**
3. **Remove the lamp cover screws.**

First read the caution and warning labels on the lamp cover. Then, remove the lamp cover screws (2) by using a coin, and take off the lamp cover.

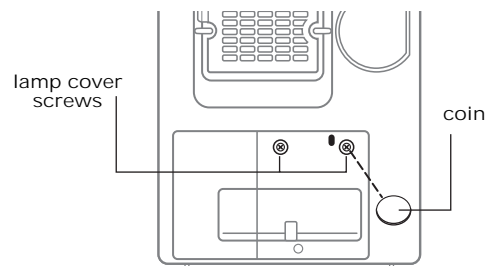

4. Remove the lamp unit screw.

Remove the lamp unit screws (2), then grasp the lamp unit handle and carefully pull it from the LCD projector. Keep the lamp housing opening to your right. Do not touch the lamp or point the lamp opening at anyone.

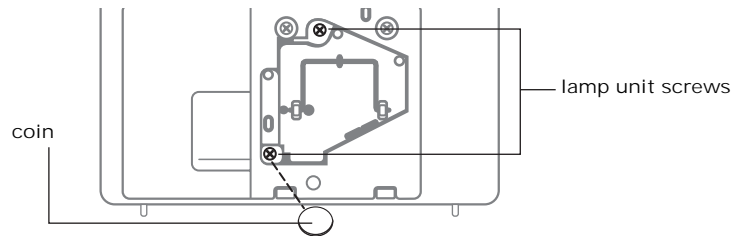

Warning: The lamp may be hot. Be careful when handling.

Caution: High-pressure lamps may explode if improperly handled.
Danger of injury due to lamp fragments.

5. Install the new lamp unit.

Remove the 630146 lamp from the LCD projector and install a new lamp unit. (630146)

Do not drop. The impact of dropping may cause the lamp to explode.

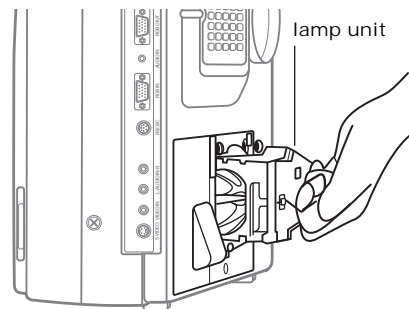

6. Replace the lamp unit screws.

Replace the lamp unit screw and the lamp cover screws using a coin to tighten. Properly dispose of the old lamp.

7. Plug the LCD projector back in by inserting the power cord into the LCD projector AC socket, and set the MAIN power switch to ON.

8. Press POWER to turn the LCD projector ON.

9. Press MENU to display the menu.

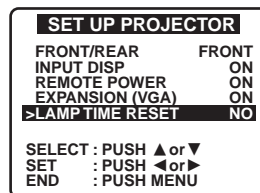
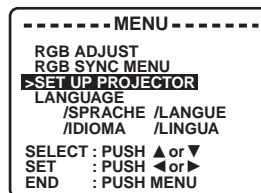

10. Press **▲** or **▼** to select SET UP PROJECTOR, and then press **◀** or **▶** to display the screen.
11. Press **▲** or **▼** to select LAMP TIME RESET, and then press **◀** or **▶** to display the screen.

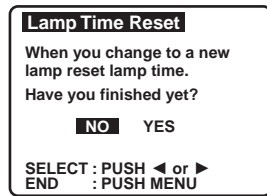

12. Press **◀** or **▶** to select YES. “Push POWER button to reset” will appear.
13. Press **POWER** to reset the lamp time to “0”.

Before Requesting Service

If the LCD projector unit fails, check the following before calling your dealer for service.

Problem	Possible Cause
<i>The power does not turn on.</i>	<ul style="list-style-type: none"> • The power cord may not be connected. • The MAIN power switch on the projector may be turned off. • The main power supply may not be supplied to the power point. • The Status Codes are indicated on the STATUS CODE Display. • The lamp unit or lamp unit cover may not have been correctly installed . • The air filter unit may not have been correctly installed.
<i>No picture appears</i>	<ul style="list-style-type: none"> • The lens cap may still be attached to the lens. • The signal input source may not be connected properly. • The input selection setting may not be correct. • The BRIGHTNESS adjustment may be at the lowest setting. • The LCD projector may be set to SHUTTER mode.
<i>The picture is fuzzy</i>	<ul style="list-style-type: none"> • The lens focus may not have been set correctly, or the projector may not be at the correct distance from the screen. • The lens may be dirty. • The LCD projector may not be set up so that it is perpendicular to the screen. • The VIDEO or R, G, B adjustments may not have been set correctly.
<i>“FOCUS” or “NO SYNC” appears on the screen.</i>	<ul style="list-style-type: none"> • The signal input source may not be connected properly. • The input selection setting may not be correct. • The connected signal source may be turned off.
<i>The color is too light or the tint is poor</i>	<ul style="list-style-type: none"> • COLOR or TINT adjustments may not have been set correctly. • The video formats may not match. • The signal connection pin assignments may not have been set correctly.
<i>No sound can be heard</i>	<ul style="list-style-type: none"> • The audio signal source may not be connected properly. • The volume adjustment may be at the lowest possible setting. • The MUTE function or Audio/Video SHUTTER function may be active.
<i>The remote control unit does not operate</i>	<ul style="list-style-type: none"> • The batteries may be spent, or they may not be inserted correctly. • There may be an object blocking the infrared signals between the remote control unit and the projector. • The remote control unit may be out of the operating range.
<i>“CARD NG” appears on screen</i>	<ul style="list-style-type: none"> • A PC-Card that is not compatible with this LCD projector is inserted

Where to get help

If at any time you need help:

- Check “Before Requesting Service” above.
- Call your dealer’s technical support line and explain your problem.
- Call Polaroid Corporation. Refer to listing of Polaroid offices and service centers.

Specifications

<i>LCD panels</i>	0.9" Polysilicon LCD panel X3, RGB shutter method, using translucent TN crystal panels	
<i>Drive method</i>	Active Matrix 4:3 aspect ratio panels, TFT (Thin Film Transistor)	
<i>No. of pixels</i>	480,000 (800 x 600) stripe pixels x 3 panels	
<i>Lens</i>	1-1.3 zoom lens, F2.5-2.7, f37-48mm manual focus	
<i>Projector lamp</i>	150 W High Pressure Mercury Lamp	
<i>Contrast ratio</i>	150:1	
<i>Brightness</i>	600 lumens	
<i>Number of colors</i>	16,777,216	
<i>Screen size</i>	20"-300" (measured diagonally)	
<i>Projection (throw) distance</i>	0.97 m-15.8 m (3.18'-51.84')	
<i>Lens axis shift</i>	1:9 Low position	
<i>Color systems</i>	PAL/SECAM/NTSC/PAL-M/PAL-N/NTSC4.43	
<i>*VIDEO input signal</i>	1Vp-p, sync negative, 75Ω terminated	
<i>*S-VIDEO input signal</i>	Y (luminance signal): 1 Vp-p, sync negative, 75Ω terminated C (chrominance signal): burst 0.286 Vp-p, 75Ω terminated	
<i>RGB input signal</i>	<i>Video signal</i>	RGB analogue (0.7 Vp-p, 1.0 Vp-p with sync on green, 75Ω) Unlimited number of colors
	<i>Sync signal</i>	H/V separate, H/V composite, or sync on green.
	<i>H-Frequency</i>	24.83-60.24 kHz (TTL Level) Refer to page 26.
	<i>V-Frequency</i>	56.25-85.1 Hz (TTL Level) Refer to page 26.
<i>RGB output signal</i>	<i>RGB</i>	RGB analogue (0.7 VP-p, 1.0 Vp-p with sync on green, 75Ω).
	<i>HD/SYNC</i>	Same polarity as HD/SYNC terminal of RGB IN connector (TTL Level)
	<i>VD</i>	Same polarity as VD terminal of RGB IN connector (TTL Level)
<i>Connectors</i>	S-Video input: Mini DIN 4-pin X 1 Video input: RCA pin X 1 Video Audio input: RCA pin X 2 (L+R) Serial port (RS-232C): Mini DIN 8-pin X 1 RGB display input: D-sub HD 15-pin X 1 RGB audio input: M3 stereo mini pin X 1 RGB display output: D-sub HD 15-pin X 1 Audio output: M3 stereo mini pin X 1 PC card slot: PCMCIA Type II X 1	
<i>Controls</i>	<i>Cabinet buttons/Switches</i>	MAIN POWER ON/OFF, VOLUME +/-, MODE, MENU, INPUT, ▲, ▼, ◀, ▶, Release
	<i>Remote control unit buttons</i>	Power ON/OFF, Freeze, Shutter, Mute, Volume +/-, Mode, Menu, Input, ▲, ▼, ◀, ▶, Light, Pointer, Mouse, Click1, Click2

<i>Audio output</i>	1.5 W (10% THD)
<i>Speaker</i>	70 mm X 40 mm X 1 (2.76" X 1.58" X 1)
<i>Operating temperature</i>	5°C to 40°C (41°F to 104°F)
<i>Operating humidity</i>	10% - 80% (non-condensation)
<i>Storage temperature/ Storage humidity</i>	-13°F to 104°F (-25°C to 40°C) / 5%-85% (non-condensing) -13°F to 140°F (-25°C to 60°C) / Normal humidity
<i>Power supply</i>	100-240 V AC (50 or 60 Hz) Automatic
<i>Power consumption</i>	260 W
<i>Dimensions (W x H x D)</i>	240 mm x 153 mm x 325 mm (9-7/16" x 6" x 12-13/16")
<i>Amps</i>	2.6A-1.2A
<i>Weight</i>	12.6 lbs. (5.8 kg)
<i>Approvals</i>	FCC, UL, C-UL, CE, VDE

Note: Specifications and design are subject to change without notice.

Polaroid Three Year Limited Warranty

Polaroid warrants your Polaview projector equipment against defects in manufacture for a period of three years from the date of purchase. To verify the warranty period, you should keep the sales slip or other proof of the purchase date.

Should this product, or any component or accessory included with it, become defective at any time during the warranty period, Polaroid Corporation will, at its discretion, either replace or repair this item, without charge, provided the product is returned to a designated servicing location (prepaid and insured). To ship the unit, pack the carrying case in the original carton or equivalent, with plenty of padding.

This Limited Warranty does not apply to product damage resulting from accident, incorrect installation, unauthorized modification, misuse or abuse.

U.S.A. and Canada

Before you return your equipment for repair, please call Polaroid Electronic Imaging Technical Support from within the U.S.A. at 1-800-432-5355, Monday through Friday, 8 a.m. to 8 p.m., Eastern Time. In Canada, call 1-800-268-6970. We can help you determine what is at fault, and advise you on how and where to get service in the quickest and most convenient way.

THIS WARRANTY EXCLUDES ALL INCIDENTAL AND CONSEQUENTIAL DAMAGES. ALL EXPRESSED OR IMPLIED LIABILITY FOR THIS EQUIPMENT INCLUDING BUT NOT LIMITED TO THE IMPLIED WARRANTY OF MERCHANTABILITY AND FITNESS FOR A PARTICULAR PURPOSE ARE LIMITED IN DURATION TO THE THREE YEAR WARRANTY PERIOD.

SOME STATES DO NOT ALLOW THE EXCLUSION OR LIMITATION OF INCIDENTAL OR CONSEQUENTIAL DAMAGES OR THE DURATION OF IMPLIED WARRANTIES SO THE ABOVE LIMITATIONS MAY NOT APPLY TO YOU. THIS WARRANTY GIVES YOU SPECIFIC LEGAL RIGHTS, AND YOU MAY ALSO HAVE OTHER RIGHTS WHICH MAY VARY FROM STATE TO STATE.

Outside the U.S.A. and Canada

THIS WARRANTY EXCLUDES ALL INCIDENTAL AND CONSEQUENTIAL DAMAGES AND DOES NOT AFFECT YOUR STATUTORY RIGHTS.

Note: No user-serviceable parts inside, with the exception of the lamp and air filter which can be replaced as described in this manual. Attempts to modify mechanical or electronic parts inside will void your warranty, and may be hazardous.

Polaroid Offices and Service Centers

Australia

Polaroid Australia Pty. Ltd.
13-15 Lyonpark Road
P.O. Box 163
North Ryde, N.S.W. 2113
Tel.: (02) 9 950 7000
Fax: (02) 887 2209

Belgique/België

Polaroid (Belgium) N.V.-S.A.
Rue Colonel Bourg 111
Kolonel Bourgstraat 111
1140 Bruxelles-1140 Brussel
Tel.: 32 2 702 86 20
Fax: 32 2 726 92 99
Toll free: 32 78 155 905

Brasil

Polaroid do Brasil Ltda.
Av. Paulista, 1776-11º andar
Cerqueira Cesar
São Paulo-Capital
01310-921
Tel.: 55.11.285.6411
Fax: 55.11.283.2625
288.6521
287.5393

Canada

Polaroid Canada Inc.
350 Carlingview Drive
Etobicoke, Ontario M9W 5G6
Toll free: 1-800-268-6970

Danmark

Polaroid a.s.
Blokken 75
3460 Birkerød
Tlf.: 42 81 75 00
Fax: 42 81 70 26

Deutschland

Polaroid GMBH
Spremlinger Landstrasse 109
63069 Offenbach
Tel.: (49-69) 840 4100
Fax: (49-69) 840 4 204

España

Polaroid (España), S.A
Calle Orense, 16
2a planta
28020 Madrid
Tno: 34-1-597.02.52
Fax: 34-1-597.27.82

France

Polaroid (France) S.A.
12 Bis Ave. Gay Lussac
La Clef de Saint-Pierre, B.P. 7
78996 Elancourt Cédex
Tel.: (33-1) 30 68 38 38
Fax: (33-1) 30 68 38 39

Hong Kong

Polaroid (Far East) Ltd.
32/F Windsor House
311 Gloucester Road
Causeway Bay
Tel.: (852) 2894 0333
Fax: (852) 2895 1382

Italia

Polaroid (Italia) S.p.A.
Via Piave 11
21051 Arcisate (Varese)
Tel.: (39-332) 470031
Fax: (39-332) 478249

Japan

Nippon Polaroid
Kabushiki Kaisha
Mori Building No. 30
Toranomon 3-2-2
Minato-ku
Tokyo 105
Tel.: (81-3) 3438 8811
Fax: (81-3) 3433 3537

México

Polaroid de México S.A. de C.V.
Paseo de la Reforma 195
Piso 17
C.P. 06500 México, D.F.
Tel.: (52-5) 703-1111
Fax: (52-5) 566-0505
Del interior al 91 (800) 70-727
Ventas 91 (800) 70-747

Nederland

Polaroid Nederland B.V.
Zonnebaan 45
3606 CH Maarssen
PO Box 1219
3600 BE Maarssen
Tel.: (31-30) 241 0420
Fax: (31-30) 241 1969
Reparaties:
Polaroid (Europe) B.V.
Hoge Bothofstraat 45
7511 ZA Enschede
Tel.: (31-53) 486 5050
Tel.: (32-53) 486 9905

New Zealand
Polaroid New Zealand Ltd.
24-26 Anzac Avenue
Auckland
Tel.: (64-9) 377 3773

Norge
Polaroid (Norge) A/S
Industriveien 8B,
1473 Skärer, Norway
Tlf: (47-67) 90 47 10
Fax: (47-67) 90 51 73

Österreich
Polaroid Ges.m.b.H.
Eitnergasse 5A
1231 Wien, Austria
Tel.: (43-1) 869 86 27
Fax: (43-1) 869 81 00

Portugal
Polaroid (Espanña) S.A.
Sucursal em Portugal
Edificio Monumental
Avenida Praia da Vitória, 71-A 4º B
1050 Lisboa
Tel.: (351-1) 316.10. 49
Fax: (351-1) 316.10. 56

Puerto Rico
Polaroid Caribbean Corporation
Centro de Seguros
Ave. Ponce de León 701
Miramar, Santurce 00907
Tel.: (1-809) 725-6240
Fax: (1-809) 725-5462

Schweiz/Suisse/Svizzera
Polaroid AG
Hardturmstrasse 133
8037 Zürich, Switzerland
Tel.: (41-1) 277.72.72
Fax: (41-1) 271.38.84

Suomi
Polaroid Oy
Sinikalliontie 10
02630 Espoo
Tel.: (358-0) 502 35 33
Fax: (358-0) 502 35 50

Sverige
Polaroid AB
Ekholmavägen 34
Box 204
127 24 Skärholmen
Tel.: (46-8) 710 08 50
Fax: (46-8) 740 73 68

U.K.
Polaroid (U.K.) Ltd. &
Polaroid Export Operations
Wheathampstead House
Codicote Road
Wheathampstead
Hertfordshire AL4 8SF U.K.
Tel: (44) 1582 63 2000
Freefone: (800) 010119

U.S.A.
Polaroid Corporation
Technical Assistance
Tel.: Toll free 1-800-432-5355
Call for the nearest Polaroid location